

YAMAHA

Digital Multi-Effect Processor

SPX90

Operating Manual

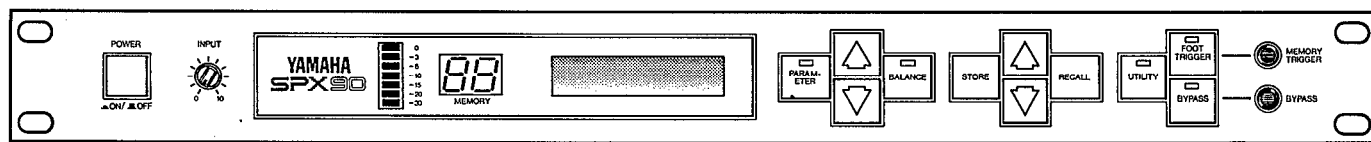

INTRODUCTION

Congratulations on your purchase of a Yamaha SPX90 Digital Multi-Effect Processor. The SPX90 is an amalgam of advanced acoustical research and digital technology designed to provide musicians and home recording enthusiasts with a wide range of exciting effects.

The SPX90 Digital Multi-Effect Processor utilizes highly refined LSI (Large Scale Integration) technology to create natural reverberation. Not only is its assortment of 30 preset effects comprehensive enough to suit most studio and performance applications, the SPX90 also allows you to create up to 60 additional effects and store them for instant recall.

Your SPX90 can create effects far beyond mere reverberation, though that in itself is of a truly superior quality. A variety of echo, delay, and special effects—each with comprehensive parameter adjustments—can be accessed at the touch of a switch. And as the SPX90 is MIDI-compatible, it can be programmed to apply separate reverberation effects to a variety of MIDI-compatible instruments.

Your SPX90 Digital Multi-Effect Processor will prove extremely useful in a variety of applications: acoustic electric, PA, MIDI instrument, and home recording systems. In order to take advantage of the vast potential of this component, we urge you to study this manual before connecting the SPX90 to your system.

We at Yamaha thank you, and wish you years of enjoyment with your SPX90.

CONTENTS

PRECAUTIONS	2	TREMOLO	13
FRONT PANEL	3	SYMPHONIC	13
REAR PANEL	4	PITCH CHANGE	13
BASIC OPERATIONS	5	FREEZE	14
PRESET PROGRAM SELECTION	5	REVERB & GATE	17
EDIT: CHANGING PARAMETERS	5	GATE	
STORE: SAVING EDITED PROGRAMS	6	ADR-NOISE GATE	17
OUTPUT BALANCE AND LEVEL		COMPRESSOR	18
PROGRAMMING	7	PAN	
BYPASS	7	AUTO PAN	19
UTILITY FUNCTIONS	8	TRIGGERED PAN	19
EDIT TITLE	8	DELAY VIBRATO	20
MIDI FUNCTIONS	8	PARAMETRIC EQ	20
FOOTSWITCH MEMORY RECALL RANGE	9	SAMPLE APPLICATIONS	21
DESCRIPTION OF PROGRAMS AND		SPECIFICATIONS	23
PARAMETERS	10	ROM CONTENTS AND CONTROLABLE	
REVERB	10	PARAMETERS	24
ER1, ER2	10	EARLY REFLECTION MODE CHART	26
DELAY	11	ROOM SIZE CHART	27
ECHO	11	BLOCK DIAGRAM	28
MODULATION		DIMENSIONS	28
STEREO FLANGE	12	USER PROGRAMMING TABLE	29
CHORUS	12	MIDI IMPLEMENTATION CHART	30
STEREO PHASING	13		

PRECAUTIONS

NOTE: It is vital to read this section before using your SPX90 Digital Multi-Effect Processor. This unit utilizes state-of-the-art digital technology which, although designed to provide years of trouble-free use, requires careful handling.

- **VOLTAGE RATINGS**

Be sure the AC supply in your area is appropriate for your SPX90.

U.S./Canadian Model: 110V — 120V, 50/60Hz.

General Model: 220 — 240V, 50/60Hz.

- **ENVIRONMENTAL TEMPERATURE**

Do not expose the SPX90 to excessive heat. The operating temperature range of this unit is between 0 and 40 degrees centigrade (32 and 104 degrees Fahrenheit).

- **EXTERNAL CLEANING**

Do not clean the exterior of the SPX90 with solvents such as benzine or paint thinner. Dust, dirt, or fingermarks should simply be removed with a soft, dry cloth. Internal cleaning of the unit should only be performed by a qualified technician.

The LCD may not function properly under extreme temperature conditions. It will return to normal after cooling down to within the proper temperature range.

- **BACKUP BATTERY**

To ensure that User Programs are not lost when the SPX90's power is turned off, a built-in long-life battery acts as a backup. In normal use, this battery lasts 5 years, but it is advisable to change the battery before this time has elapsed. Contact your local Yamaha dealer for details.

NOTE: When you change the battery, the User Programs may be lost. As a safeguard, take note of all parameters of your User Programs in the USER PROGRAMMING TABLE accompanying this manual. The SPX90 can then be reprogrammed once a new battery is installed. The preset programs are permanent, and will not be affected by a change of battery.

- **ERROR MESSAGES**

When power is initially turned ON an automatic circuit test program is executed to ensure proper operation. If an error is encountered, one of the following error messages will be displayed:

E0 : ROM checksum error.

E1 : CPU RAM read/write error.

E2 : External RAM read/write error.

Make a note of the error message and inform the service personnel when the unit is to be serviced.

FCC CERTIFICATION (USA)

This equipment generates and uses radio frequency energy and if not installed and used properly, that is, in strict accordance with the manufacturer's instructions, may cause interference to radio and television reception. It has been type tested and found to comply with the limits for a Class B computing device in accordance with the specifications in Subpart J of Part 15 of FCC Rules, which are designed to provide reasonable protection against such interference in a residential installation. However, there is no guarantee that interference will not occur in a particular installation. If this equipment does cause interference to radio or television reception, which can be determined by turning the equipment off and on, the user is encouraged to try to correct the interference by one or more of the following measures:

Reorient the receiving antenna.

Relocate the computer with respect to the receiver.

Move the computer away from the receiver.

Plug the computer into a different outlet so that computer and receiver are on different branch circuits.

If necessary, the user should consult the dealer or an experienced radio/television technician for additional suggestions. The user may find the following booklet prepared by the Federal Communications Commission helpful:

"How to identify and Resolve Radio-TV interference Problems".

This booklet is available from the U.S. Government Printing Office, Washington, DC 20402, Stock No. 004-000-00345-4.

FRONT PANEL

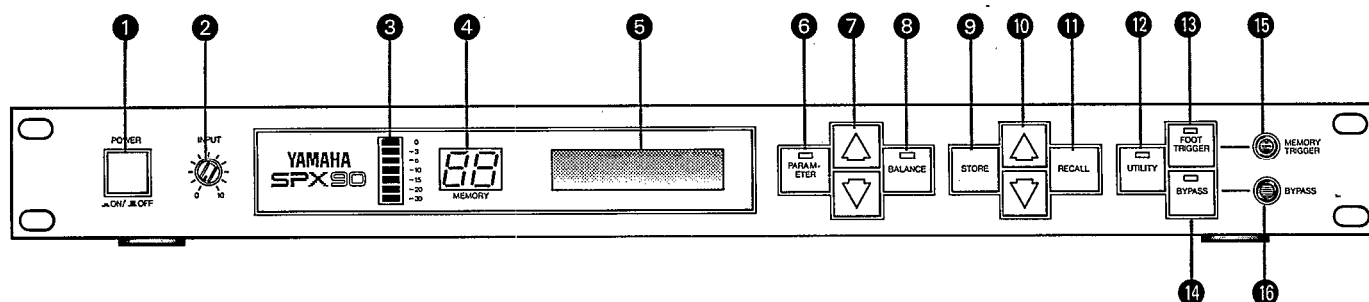

1 Power ON/OFF Switch

When the power is turned ON, the program which was selected immediately before the power was turned OFF will be re-selected. Due to the safety muting circuit, no sound will be produced by the SPX90 for a few seconds after the power is turned

2 Input Level Control (0 ~ 10)

Regulates the level of the input signal. Set the INPUT LEVEL control while watching the INPUT LEVEL meter. The seven LED meter segments should not all be continuously on when an input signal is applied, as this will result in input amplifier overload and distortion. When the INPUT LEVEL control is set to "8" on the scale, the input/output gain is 1 (unity). A setting of "10" increases gain by about 10 dB.

3 Input Level Meter

This easy-to-read LED level meter is a visual aid to setting appropriate input levels. Generally, the best input level setting will produce continuous lighting of the lower green LED segments, while the upper red segments flash only occasionally.

4 Memory Number LED

This LED display shows the number of the currently selected program. Memory numbers 1 through 30 contain factory-preset effects (ROM). Memory numbers 31 through 90 can be used to store edited versions of the preset effects (RAM).

5 LCD Program and Parameter Indicator

This high-contrast Liquid Crystal Display indicates the effect name and parameter data value.

6 Parameter Key

Selects successive effect parameters. Pressing this key sequentially calls the programmable parameters within the currently selected effect program. Once the desired parameter has been selected, the PARAMETER INCREMENT/DECREMENT keys are used to change the value of that parameter, thereby modifying the effect. The parameters available for each program are different: refer to the parameter chart on page 24.

7 Parameter Increment/Decrement Keys

These keys are used to change the value of a selected parameter. Press the increment key (up arrow) to increase the value, or the decrement key (down arrow) to decrease the value.

8 Balance/Output Level Key

Adjusts proportion of effect signal to direct signal. Pressing this key alternately causes the current balance and output level values to be displayed on the LCD. The Parameter Increment/Decrement keys are then used to adjust the displayed values.

9 Store Key

Stores any edited preset effect in a selected RAM memory position (31 ~ 90).

10 Memory Increment/Decrement Keys

These keys select any desired memory number to call a specific program or store an edited program in the user memory area. The selected memory number is shown on the MEMORY NUMBER display. When a new memory number is called, the MEMORY number display will flash until either the STORE or RECALL function is activated.

11 Recall Key

Press this key to recall the program that resides in the selected memory number.

12 Utility Key

Multi-purpose key accesses MIDI control functions, facilitates program title editing and sets footswitch memory control range. See pages 8 and 9 for details.

13 Foot Trigger Key

When this key is pressed and its LED is ON, the footswitch connected to the Memory/Trigger jack functions as a foot trigger for the GATE and FREEZE programs, rather than for memory selection.

14 Bypass Key

When this key is pressed, the effect signal is shut off and only the direct signal will be output. Direct signal level is affected by the INPUT LEVEL control setting.

15 Memory/Trigger Footswitch Jack

Facilitates remote memory selection via optional footswitch. The range of memory locations to be recalled by the footswitch can be set with a Utility program. When the foot trigger function (above) is ON, the footswitch connected to this jack acts as a trigger footswitch rather than memory control. Use of a Yamaha FC5 Foot Controller is recommended.

16 Bypass Footswitch Jack

Facilitates foot control of the BYPASS function described above. A Yamaha FC-5 Foot Controller is recommended.

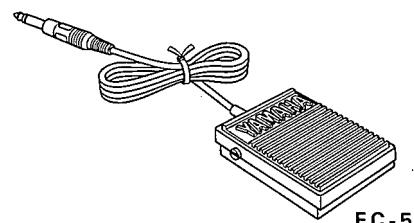

REAR PANEL

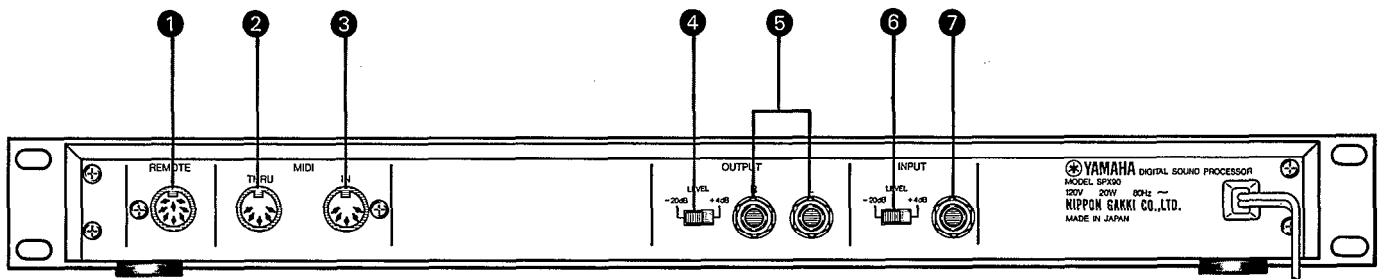

U.S. & Canadian models

1 Remote Control Connector

Permits remote access to SPX90 effect programs. The optional remote control unit, model RC7, permits direct access to programs 1 through 7 and 31 through 37, while all other preset programs may be accessed sequentially.

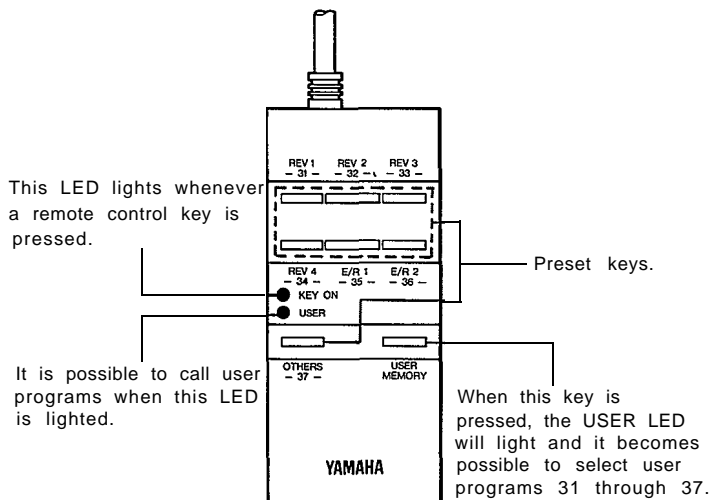

2 MIDI THRU Connector

Re-transmits MIDI data received at the MIDI IN connector to subsequent MIDI instruments.

3 MIDI IN Connector

Permits SPX90 effect programs to be automatically selected via a MIDI signal. This connector must be connected to the MIDI OUT connector of the transmitting MIDI instrument via a standard MIDI cable.

4 Output Level Selector (-20 dB, +4 dB)

Facilitates SPX90 source/line level (sensitivity) matching.

5 Output Jacks (L and R)

These are standard mono 1/4" phone jacks which deliver the direct and effect signal to subsequent mixing or amplification equipment. Since the SPX90 offers stereo output, we recommend that the output signal be fed in stereo to a stereo sound system in order to take full advantage of the superb stereo effects provided. Output impedance is 600 ohms.

6 Input Level Selector (-20 dB, +4 dB)

Permits SPX90 source/line level (sensitivity) matching.

7 Input jack

This standard unbalanced mono 1/4" phone jack accepts the input signal to the SPX90. Input impedance is 10 k-ohms.

USER LED OFF — Preset programs —	USER LED ON — User programs —
1. REV 1 HALL	31. User program
2. REV 2 ROOM	32. User program
3. REV 2 VOCAL	33. User program
4. REV 4 PLATE	34. User program
5. EARLY REFLECTION 1	35. User program
6. EARLY REFLECTION 2	36. User program
7. DELAY L, R	37. User program
↓	
30. PARAMETRIC EQ (Programs 8 through 30 selected sequentially by pressing OTHERS/ -37- key)	

BASIC OPERATIONS

Before actually selecting or editing programs on your SPX90, make sure that all connections have been made properly, and that the INPUT LEVEL switch, OUTPUT LEVEL switch, and INPUT LEVEL control have been properly set according to the source signal and equipment to which the SPX90 signal will be fed.

PRESET PROGRAM SELECTION

Your SPX90 is equipped with a selection of 30 outstanding preset effect programs which are listed in the ROM CONTENTS AND CONTROLABLE PARAMETERS on page 24. The preset (and user) programs are selected as follows:

1. Use MEMORY INCREMENT/DECREMENT keys to select desired memory number (remember, 1 through 30 are the presets).
2. Press RECALL key to call program in selected memory number.

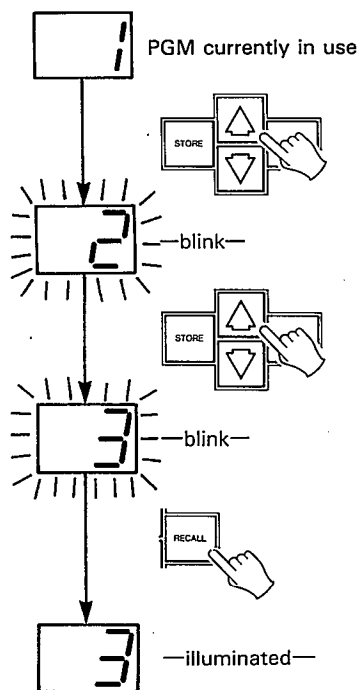

NOTE: The same process is used to select user programs (memory number 31 through 90) once you have edited and stored your own programs in user memory.

EDITING: CHANGING PARAMETERS

The SPX90 offers incredible sonic flexibility, as each effect type comprises its own set of parameters (see parameter chart on page 24). These parameters can be adjusted to suit your tastes and the tonal characteristics of your musical equipment. We therefore recommend that you examine each preset effect program, and observe how these parameters affect the sound. You will soon discover many new and exciting applications for the SPX90's preset effect programs.

1. Select and recall desired program as described above.
2. Press PARAMETER key to access the various parameters available in the selected program. Each time the PARAMETER key is pressed, the next parameter in the list is called.

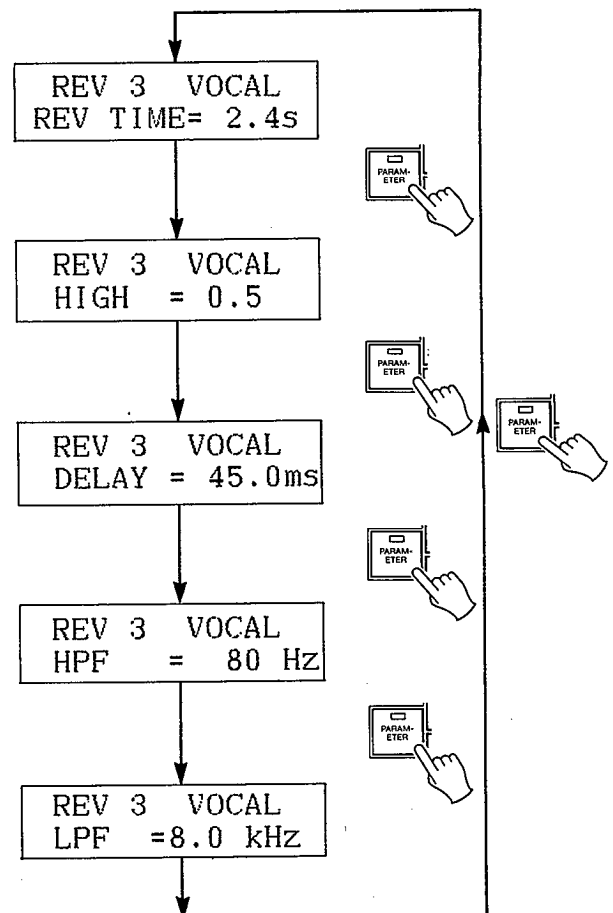

- Use PARAMETER INCREMENT/DECREMENT keys to set desired value of the selected parameter.

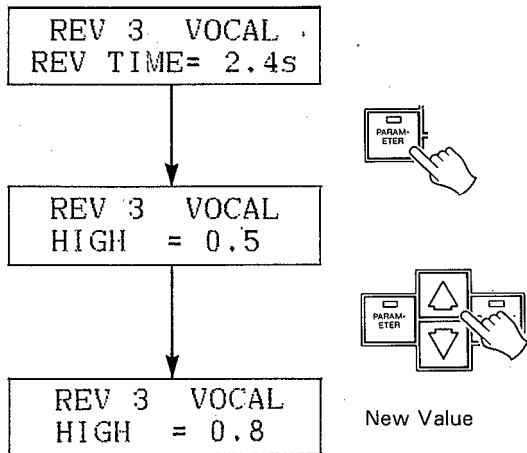

NOTE: A description of each parameter and its effect will be given in the PROGRAMMABLE PARAMETERS section, beginning on page 10.

STORE: SAVING EDITED PROGRAMS

Once you've edited parameters on a preset program, those changes will remain in effect only until you select (RECALL) another program. The STORE function, however, allows you to save the edited program in any one of the user memory locations — from 31 to 90 — from which it can then be recalled at any time.

- Select and edit a program as described above.
- Use the MEMORY INCREMENT/DECREMENT keys to select a clear memory location between 31 and 90.
- Press the STORE key.

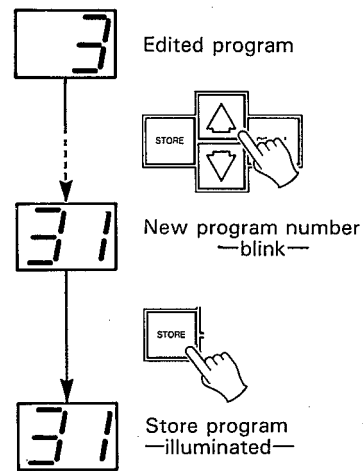

The edited program has now been stored in the selected user memory location. The stored program may now be recalled at any time by following the normal program selection procedure.

NOTE: If you attempt to store a program in one of the read-only preset locations (1 through 30), the SPX90 will display the “# 1 ~ # 30 READ ONLY” error message.

: SPX90 has an Edit Title Function, so you can which allows you to provide your own titles for edited programs. (See the UTILITY function on page 8.)

OUTPUT BALANCE AND LEVEL PROGRAMMING

The BALANCE key selects the BALANCE and OUTPUT LEVEL functions for all programs.

1. Press the BALANCE key while any parameter is selected.
2. The first function called will be BALANCE. Adjust the BALANCE of the effected and direct signal between 0 and 100% using the PARAMETER INCREMENT/DECREMENT keys.

* Balance = 100% : effect sound only.
Balance = 0% : direct sound only.

3. Press the BALANCE key again to call the OUTPUT LEVEL function. Adjust using the PARAMETER INCREMENT/DECREMENT keys.

* OUT LVL = 100% : maximum output level.
OUT LVL = 0% : no sound will be output.

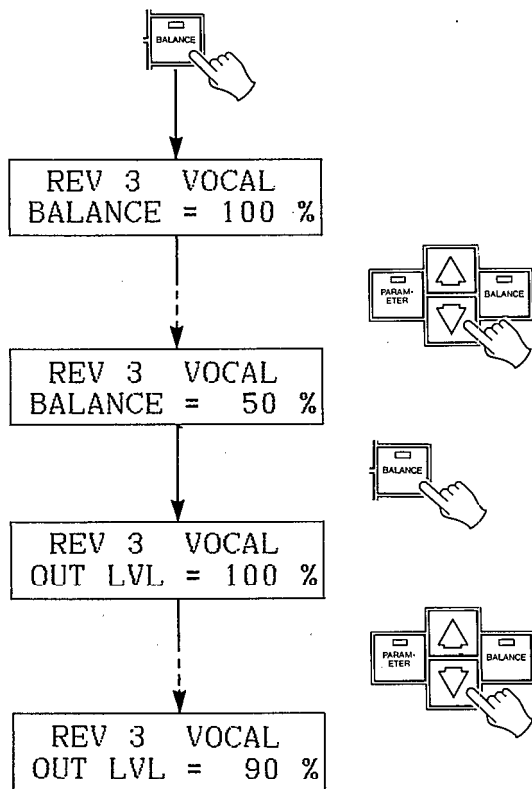

BYPASS

When the BYPASS key is pressed and its LED lights, the effect signal is defeated and only the direct input signal is delivered via the OUTPUT jacks. The BALANCE and OUTPUT LEVEL functions are also bypassed. The BYPASS function can also be activated via a footswitch connected to the BYPASS jack. A normally-closed-type footswitch such as the Yamaha FC-5 must be used.

UTILITY FUNCTIONS

The UTILITY key provides access to four utility functions. These functions are selected in the following sequence each time the UTILITY key is pressed:

Normal mode → EDIT TITLE → MIDI CONTROL →
MIDI PROGRAM CHANGE → FOOTSWITCH
MEMORY RECALL → Normal mode.

The UTILITY key LED will light during selection of the four utility functions, and will go out when the normal mode is returned to. When the UTILITY LED is ON, the PARAMETER and MEMORY NUMBER INCREMENT/DECREMENT keys will perform special functions as described below, so normal parameter and memory selection can not be performed until the normal mode is selected.

EDIT TITLE

This function makes it possible to provide new titles for programs which you have edited and stored in user memory (31 through 90). When the EDIT TITLE function is called, the lower line of the LCD will display the "EDIT TITLE" function name, and the upper line will display the title of the currently selected program. The PARAMETER and BALANCE keys can then be used to move the cursor left and right, respectively, to select the character to be changed. Place the cursor over a character, then use the PARAMETER INCREMENT/DECREMENT keys to scroll through the character list, stopping at the desired character. Move the cursor to the next character location and repeat this operation until the new title is complete.

The available characters are as follows:

#	0	1	2	3	4	5	6	7	8	9	A	B	C	D	E	F
G	H	I	J	K	L	M	N	O	P	Q	R	S	T	U	V	X
Y	Z	a	ä	b	c	d	e	f	g	h	i	j	k	l	m	n
o	ö	p	q	r	s	t	u	ü	v	w	x	y	z	[]	<
>	:	.	*	+	-	=	&	/	,	.	%	!	?	→	←	
「	」	“	”	。-	ア	イ	ウ	エ	オ	カ	キ	ク				
ケ	コ	サ	シ	ス	セ	ソ	タ	チ	ツ	ッ	テ	ト	ナ	ニ	ヌ	ノ
ハ	ヒ	フ	ヘ	ホ	マ	ミ	ム	メ	モ	ヤ	ユ	ヨ	ラ	リ		
ル	レ	ロ	ワ	ヲ	ン											

MIDI FUNCTIONS

With the SPX90 it is possible to select specific programs via external MIDI control. For example, you can set the SPX90 so that when you select a specific voice on your MIDI synthesizer, the most appropriate effect program for that voice is selected automatically. In this case, the SPX90 is detecting the MIDI Program Change signal. For the following programs only, the SPX90 also detects the MIDI Note ON/OFF signal:

- * GATE programs (GATE ON/OFF).
- * PITCH programs (sets pitch).
- * FREEZE programs (begin playback).

For MIDI program change operation, it is possible to program four independent sets of program change/memory number combinations. These are referred to as "banks" in the SPX90. For example, you could program the four banks with different combinations as shown in the chart below.

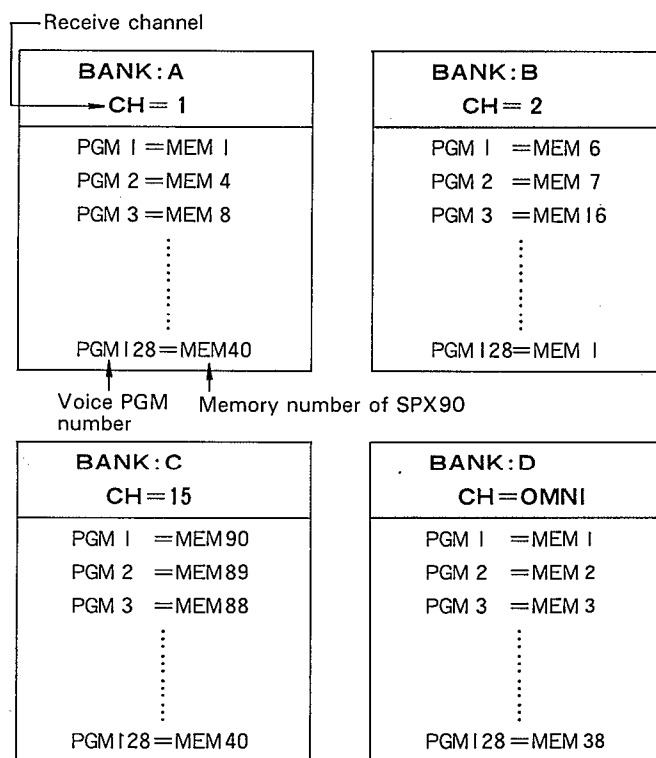

The second function accessed by the UTILITY key — MIDI CNTRL — permits BANK selection and setting of the MIDI channel number on which MIDI program change data for that BANK will be received. The third function accessed by the UTILITY key — MIDI PGM CHANGE — makes it possible to set the SPX memory number which will be called when a specific MIDI program change number is received.

MIDI Bank and Channel Programming

When this function is called, the LCD will appear as follows:

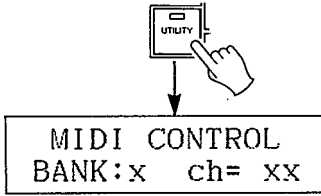

Use the PARAMETER INCREMENT/DECREMENT keys to select the desired BANK, and the MEMORY INCREMENT/DECREMENT keys to select the desired MIDI channel number for that BANK. When "CH = OMNI" is selected, reception will be carried out on all 16 MIDI channels simultaneously. When CH = OFF is selected, MIDI reception will be turned OFF.

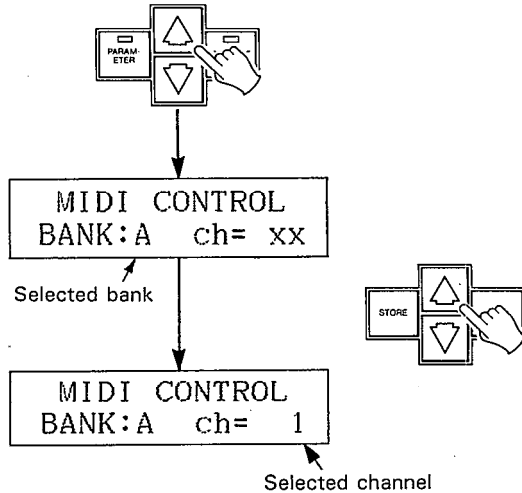

Setting MIDI Program Number/SPX90 Memory Number Combinations.

When this function is called by pressing the utility key again the LCD will appear as follows:

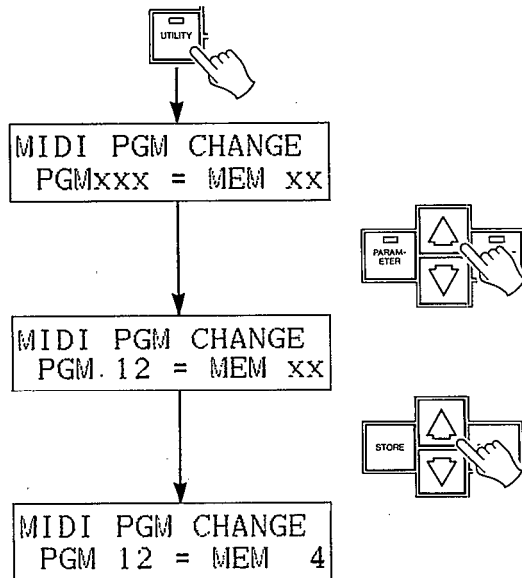

Use the PARAMETER INCREMENT/DECREMENT keys to set the MIDI program number (PGM), and the MEMORY INCREMENT/DECREMENT keys to select the SPX90 memory number (MEM) to be called when that program number is received. For example, if "PGM 12 = MEM 4" is set, SPX90 memory number 4 will automatically be called whenever voice number 12 is selected on your MIDI synthesizer.

The MIDI program number range is from 1 to 128, while the SPX90 memory number range is from 1 to 90.

FOOTSWITCH MEMORY RECALL RANGE

The SPX90 permits memory number selection via a footswitch plugged into the front-panel MEMORY/TRIGGER jack. The fourth function accessed by the UTILITY key — FOOTSWITCH MEMORY RECALL — permits setting the range of memory numbers to be selected via the footswitch.

F.SW MEMORY RCL
RANGE 1 TO 30

If, for example, the RANGE is set to "1 TO 30" as shown on the LCD above, each press on the footswitch will successively call the next highest memory number: 1 → 2 → 3 30 → 1. Note that the sequence returns to the first number in the range once the highest number is passed. Reverse sequences can be programmed by entering the highest number in the range before the lowest.

F.SW MEMORY RCL
RANGE 34 TO 31

In this case the sequence is: 34 → 33 → 32 → 31 → 34, etc.

DESCRIPTION OF PROGRAMS AND PARAMETERS

The preset programs in the SPX90 fall into the following types: REV (Reverb), ER1 and ER2 (Early Reflections), DELAY, ECHO, MOD (Modulation), GATE, PITCH, FREEZE, PAN, VIBRATO and PEQ (parametric equalizer). Each of these program types has a specific selection of programmable parameters.

“Parameters” indicates the separate, individual functions that make up each effect. There are two types of parameters in the SPX90: “invisible” parameters (non-programmable, fixed-value parameters) and programmable parameters (those you can edit, or modify).

REV (REVERB)

Most commonly associated with-musical “ambience,” reverberation is a result of myriad reflected sound waves within an acoustical environment, i.e. a concert hall, auditorium, or soundstage. The SPX90 creates extremely vibrant, natural sounding reverb.

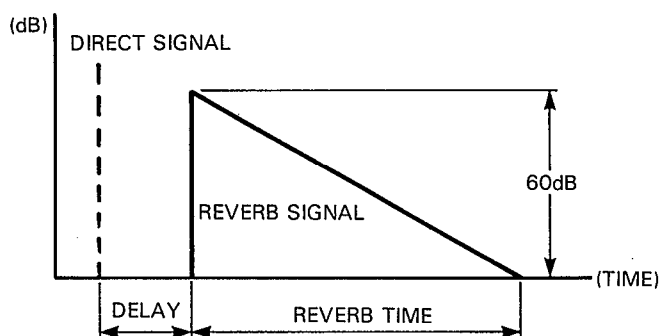

1. REVERBERATION TIME (R/T). Range: 0.3 ~ 99.0 sec

The length of the time it takes for the level of reverberation at 1 kHz to decrease by 60 dB—virtually to silence. In a live setting, this depends on several factors: room size, room shape, type of reflective surfaces, among others.

2. HIGH (High Frequency Reverb Time Ratio). Range: 0.1 ~ 1.0

Natural reverberation varies according to the frequency of the sound — the higher the frequency, the more the sound tends to be absorbed by walls, furnishings, and even air. This parameter permits you to alter the reverberation time of the high frequencies in proportion to the mid-frequency reverb time.

3. DELAY. Range: 0.1 ~ 50.0 msec

For a listener in a concert hall; there is a time delay between the direct sound of the instrument, and the first of the many reflected sounds that together are known as reverberation. On the SPX90, this is known as the DELAY time.

4. HPF (High Pass Filter). Range: THRU, 32 Hz ~ 1 kHz

Permits cutting the low frequency content of the reverb signal below the set frequency. When set to THRU, the HPF is OFF.

5. LPF (Low Pass Filter). Range: 1 kHz ~ 11 kHz, THRU

Permits cutting the high frequency content of the reverb signal above the set frequency. When set to THRU, the LFP is OFF.

ER1 and ER2 (Early Reflections)

“Early Reflection” effects. ER1 has fewer reflections, and is a LOW DENSITY early reflection effect, while ER2 has more reflections, and is a HIGH DENSITY early reflection effect.

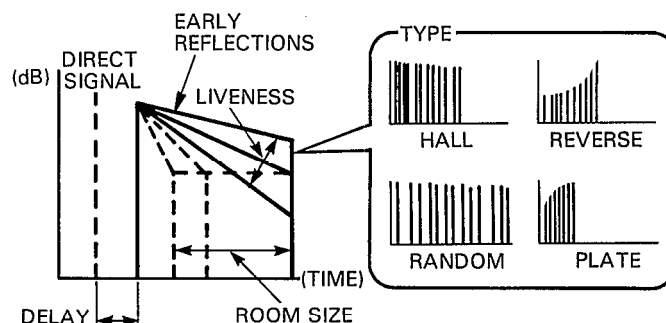

1. TYPE. Range: HALL, RANDOM, PLATE, REVERSE

TYPE selects the pattern of the earliest reflections of the reverb sound. All “Early Reflection” presets are switchable between 4 different types. These are HALL (a typical grouping of early reflections that would occur in a performing environment like a hall), RANDOM (an irregular series of reflections that could not occur naturally), PLATE (a typical grouping of early reflections that would occur in a plate reverb unit), and REVERSE (a series of reflections that increase in level, like the effect produced by playing a recorded reverb/echo backwards). See the E/R Mode chart on page 26.

2. ROOM SIZE. RANGE: 1.0 ~ 20.0

The ROOM SIZE parameter sets the time “gaps” between the early reflections — directly proportionate to the size of the room. The effect of this parameter also depends on which Early Reflection mode has been selected. A Room Size Chart can be found on page 27 in this manual.

3. LIVENESS. Range: 0 ~ 10

Refers to the rate at which the reflected sounds fade. Set this parameter at zero to simulate an acoustically “dead” room, with absorbent surfaces to “soak up” the reflected sounds. As you increase the setting, the room appears to contain more “live” surfaces, with the reflected sounds fading more slowly, as they reflect from wall to wall, until at the maximum setting the effect is of an intensely reflective environment containing many highly polished surfaces (tiles, glass, etc).

4. DELAY. Range: 0.1 ~ 400 msec

The time delay between the direct sound of the instrument and the first reflection to reach the listener’s ear.

5. LPF Range: 1 kHz ~ 11 kHz, THRU

Same function as the LPF parameter of the programs.

DELAY

This effect, commonly used in contemporary recordings, produces independently variable left- and right-channel signal delays. The result is an intriguing “doubled” sound.

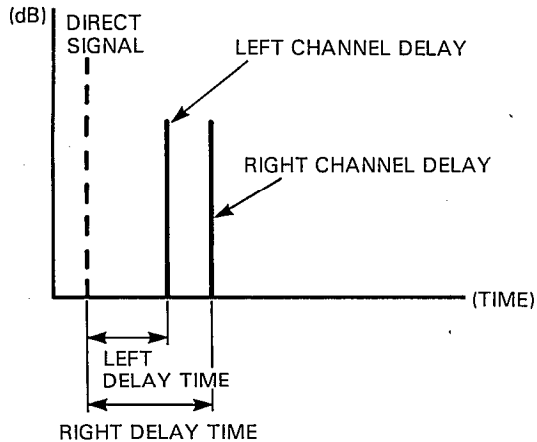

1. **LEFT CHANNEL DELAY TIME. Range: 0.1 ~ 500.0 msec**
Permits highly accurate setting of the left channel delay following the direct sound.
2. **LEFT CHANNEL FEEDBACK GAIN. Range: - 99% ~ + 99%**
Sets the amount of delay signal fed back to the input circuitry. The higher the feedback gain setting the greater the number of delay repeats produced. A negative value setting produces out of phase feedback.
3. **RIGHT CHANNEL DELAY TIME. Range: 0.1 ~ 500.0 msec**
Sets the delay time of the right channel.
4. **RIGHT CHANNEL FEEDBACK GAIN. Range: - 99% ~ + 99%**
Permits setting the feedback gain setting of the right channel delay.
5. **HIGH (FEEDBACK HIGH). Range: 0.1 ~ 1.0**
Controls feedback of the high-frequency range. The high frequency feedback is reduced as the value of this parameter is reduced.

ECHO

Similar to Delay, Echo brings added dimension and force to both instrumental and vocal music. While Reverberation recreates an abundance of partial sound reflections, and Delay produces a limited number of signal repetitions, Echo can produce limitless signal repetitions.

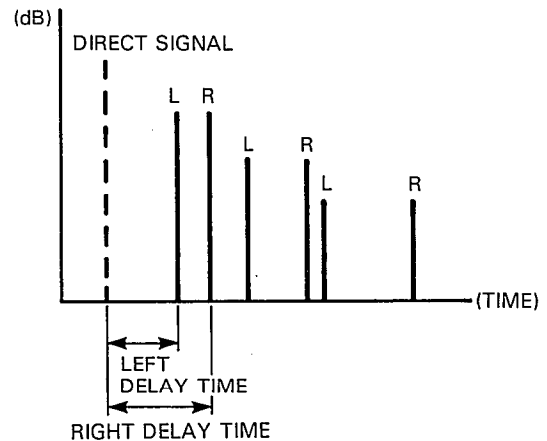

1. **LEFT CHANNEL DELAY TIME. Range: 0.1 ~ 250.0 msec**
After this delay time has elapsed, the first echo will appear. Subsequent echoes will appear at the same time interval, the number of echoes depending on how the Feedback Gain parameter is set.
2. **LEFT CHANNEL FEEDBACK GAIN. Range: - 99% ~ + 99%**
This parameter permits adjustment of the number of echoes that follow the direct signal, from zero to a virtually infinite repeat at the maximum setting. The overall decay time of the effect is proportionate to the Feedback Gain setting.
3. **RIGHT CHANNEL DELAY TIME. Range: 0.1 ~ 250.0 msec**
4. **RIGHT CHANNEL FEEDBACK GAIN. Range: - 99% ~ + 99%**
Parameter 3 and 4 have the same function as those of 1 and 2 but the signal will be produced from the Right output.
5. **HIGH (FEEDBACK HIGH). Range: 0.1 ~ 1.0**
Determines the portion of high frequency feedback. The lower the value, the less high frequency is produced.

MODULATION

STEREO FLANGE

A combination of Delay and LFO (Low Frequency Oscillation) modulation, the popular Flanging effect can dramatically thicken the sound of keyboard instruments, or produce the “aircraft” sound popular among guitarists. Basically, a short delay time is varied with LFO modulation so that the delayed signal moves in relation to the direct signal. The resultant variations in pitch and stereo imaging are known as “flanging”.

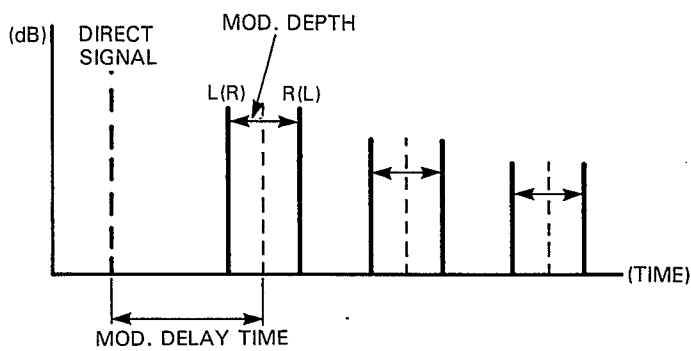

- 1. MOD FREQ. Range: 0.1 ~ 20.0 Hz**
Sets the speed of modulation, and hence the rate at which the effect varies.
- 2. MOD DEPTH. Range: 0 ~ 100%**
This sets the amount of delay time variation, thus adjusting the “depth” of the effect. At the maximum setting, the delay time is varied by +/- 4 msec.
- 3. MOD DELAY TIME. Range: 0.1 ~ 100 msec**
This sets the basic delay time from the initial direct sound to the flange effect. When set to lower than 1 msec, more high-frequency variation is produced, while a setting higher than 3 msec will create more low-frequency variation.
- 4. F. B. GAIN. Range: 0 ~ 99%**
Sets the amount of flange signal which is fed back into the circuit for further modulation. This controls the complexity of the effect, its “strength,” and its overall decay time.

CHORUS

With the Chorus effect, a violin, keyboard, or guitar can sound like an entire ensemble. Chorusing splits the incoming signal into three signals placed at the center, left, and right in the stereo image. Each signal is delayed slightly, and then its delay time and level are modulated by the LFO (Low Frequency Oscillator).

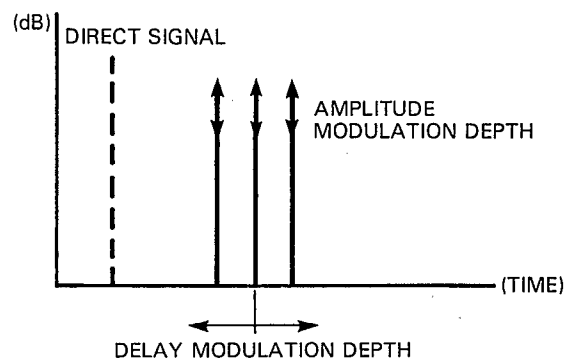

- 1. MOD FREQ. Range: 0.1 ~ 20.0 Hz**
Sets the delay time modulation speed (frequency).
- 2. DELAY MODULATION DEPTH. Range: 0 ~ 100%**
This sets the amount by which the delay time of one delay signal is varied in relation to the other. At the maximum setting, the delay time is varied by +/- 4 msec.
- 3. AMPLITUDE MODULATION DEPTH. Range: 0 ~ 100%**
This sets the amount by which the amplitude (level) of the input signal is varied.

STEREO PHASING

The SPX90 can produce a wide range of Phasing effects from a barely perceptible shift to a rapid pulsation. Phasing lends an animated quality to musical instrument and vocal recordings:

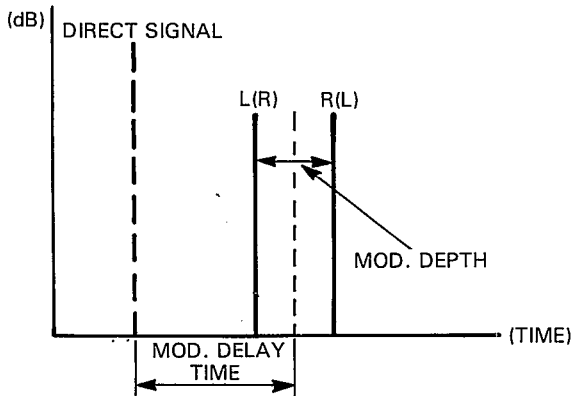

This effect has the same parameters as STEREO FLANGE, except that the DELAY TIME range is from 0.1 to 8.0 msec and omits FB Gain.

TREMOLO

The TREMOLO effect operates in the same way as the CHORUS effect, except that modulation is deeper and the delay variation is greater. Refer to STEREO FLANGE for the description of the parameters.

SYMPHONIC

The programmable parameters for this preset are identical to those for the Stereo Flange preset, omitting FEEDBACK GAIN and MOD DELAY.

PITCH CHANGE

This program is used to change the pitch of an input signal. Pitch can be changed in semitone increments over a plus/minus one-octave range. Fine adjustment of pitch in one-cent (1/100th of a semitone) increments/decrements is also possible.

Pitch change programs B and C permit setting two different pitches. This makes it possible to produce harmonizer type effects (i.e. when you play a note the SPX90 outputs two additional notes), or, if only a slight pitch difference is used, chorus-type effects are created.

Pitch change programs A and D permit the application of feedback so that an echo that changes in pitch with each repeat can be produced. Programs A and D further permit pitch control via the MIDI IN connector. Any MIDI synthesizer, such as the Yamaha DX7, can be used to alter the pitch setting of the program by simply playing the appropriate note on the synthesizer keyboard.

PROGRAM	PITCH CHANGE	FEEDBACK	MIDI PITCH CONTROL
PITCH CHANGE A	1 TONE	YES	YES
PITCH CHANGE B	2 TONES (CENTER)	NO	NO
PITCH CHANGE C	2 TONES (1 EACH IN L & R CH.)	NO	NO
PITCH CHANGE D	1 TONE	YES	YES

1. PITCH. Range: - 12 ~ + 12

Sets the degree of pitch change in semitone steps. + 12 corresponds to an output pitch one octave higher than the input pitch, and - 12 produces an output pitch one octave lower than the input pitch.

2. FINE. Range: - 100 ~ + 100

Adjusts pitch in one-cent increments or decrements.

3. DELAY Range: 0.1 ~ 400 msec (A, B, D), 0.1 ~ 200 msec (C)

Sets the delay between the direct (input signal) and the pitch-changed output signal.

4. F. B. GAIN. Range: 0 ~ 99% (A, D only)

The higher this setting, the more echo repeats are produced (each changed in pitch from the previous repeat).

5. BASE KEY. Range: OFF, C1 ~ C6 (A, D only)

This parameter sets the "BASE KEY" for an external MIDI synthesizer used to control the pitch varia-

tion of the PITCH CHANGE program. For example, if BASE KEY = C4, then pressing the C3 key on the synthesizer keyboard will set the pitch change value to - 12 (one octave down). Pressing D4 on the keyboard would produce a pitch increase of one tone (+ 2). If a key more than one octave higher or lower than the BASE KEY is pressed, the resultant pitch change setting will still be within the + 12 to - 12 range, as shown in the following illustration. If the BASE KEY setting is OFF, pitch can not be controlled via the MIDI IN terminal.

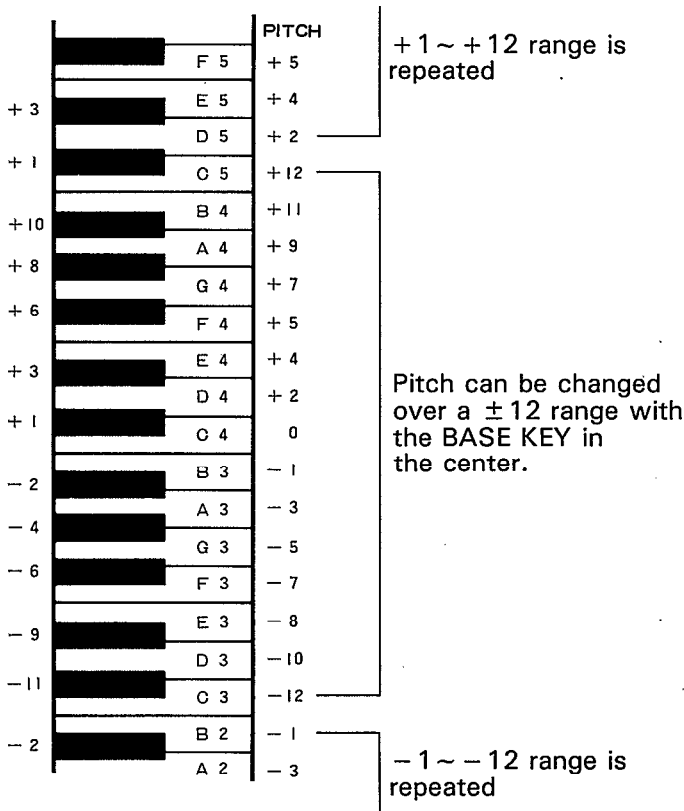

FREEZE

The FREEZE programs permit "recording" up to a 500-millisecond signal in the SPX90 memory; and playing it back as required. The FREEZE programs have two basic steps: RECORD and PLAY.

With the FREEZE A program it is possible to program a specific segment of the recorded 500-millisecond signal to be replayed by programming the START and END points.

The FREEZE B program does not permit programming START and END points, but the pitch of the recorded signal can be changed for playback.

1. REC. MODE Selection. Range: Manual, Auto

Press the Parameter key and select the Manual mode with the Parameter Increment key or AUTO Mode by pressing the Parameter Decrement key.

In the MANUAL mode a Parameter Increment panel key is pressed to begin recording, while in the AUTO mode recording begins automatically when the SPX90 detects an input signal.

2. TRIGGER DELAY Parameter. Range: - 500 ~ 500 msec.

This parameter determines the actual point at which recording begins in relation to the trigger signal. If TRG DLY is set at 0, recording begins immediately when the FREEZE function is triggered. If a negative TRG DLY value is set the input signal is delayed so that in effect recording begins before the function is triggered.

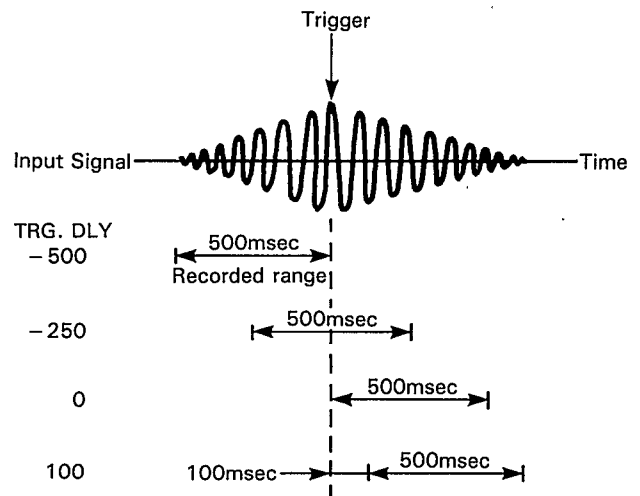

3. RECORDING

After the desired MODE has been set, press the PARAMETER key and the LCD will display the "RECORD" message. Then, enter the standby mode by pressing the PARAMETER DECREMENT key. The LCD will display the "REC READY" message.

TRIGGERING

● **MANUAL Mode**

To actually begin recording if the MANUAL mode has been selected, press the PARAMETER INCREMENT key. The SPX90 will record for 500 milliseconds.

Also the optional foot switch FC-5 can be used. Connect the FC-5 to the MEMORY/TRIGGER Foot Switch Jack and press the FOOT TRIGGER Key. Then FC-5 works as the trigger switch when it is pressed.

● **AUTO Mode**

If the AUTO mode has been selected, the SPX90 will automatically begin recording when an input signal of sufficient level is detected.

The LCD displays "TRIGGER!" when the freeze function is triggered.

When the recording begins the LCD displays "....."

The freeze (recording) ends automatically after 500msec and the display says "OK".

4. OVERDUB Recording

To "overdub," or record new material without erasing the previously recorded material, use the following procedure.

1. Press the PARAMETER key until the OVERDUB display appears.
2. Press the PARAMETER DECREMENT key. This sets the record ready status, and recording will begin as soon as a trigger signal is received.

● **FREEZE operation**

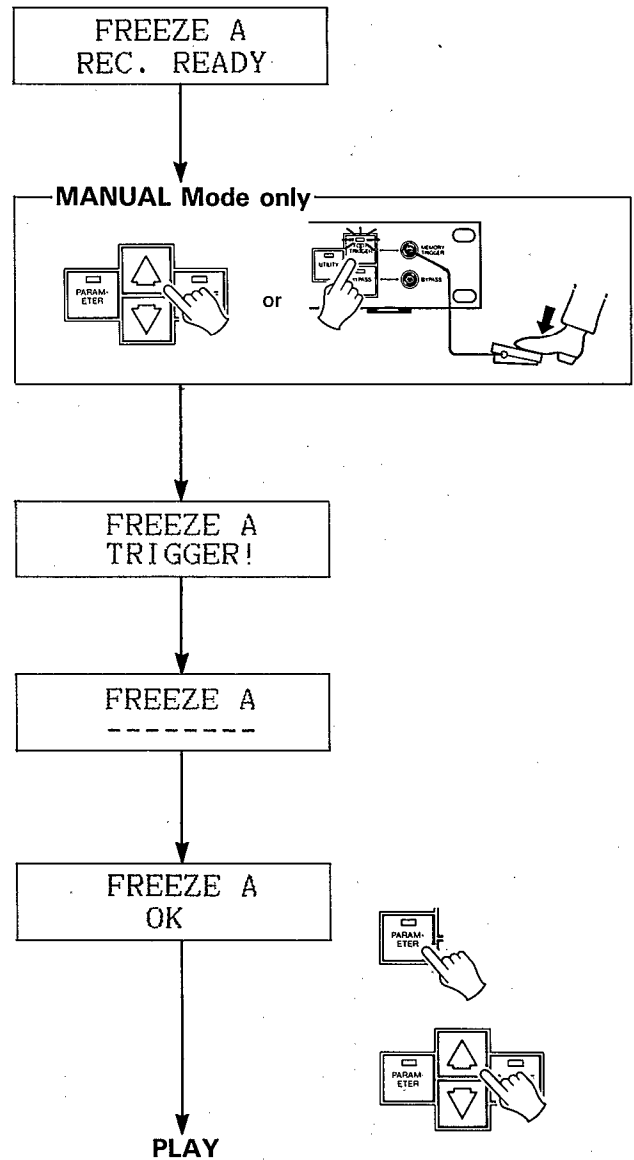
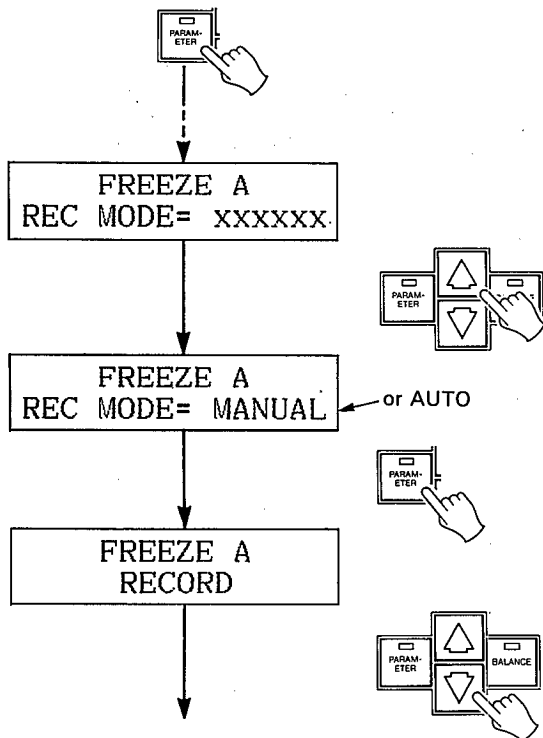

* To begin recording again, press the parameter decrement key to enter the Rec Ready Mode.

5. PLAYBACK

To play back the recorded material, press the PARAMETER key to enter the playback standby mode. The LCD will display the "PLAY" message. To actually play the recording, press the PARAMETER INCREMENT/DECREMENT key. The recorded material will be played each time the PARAMETER INCREMENT/DECREMENT key is pressed.



FREEZE A
PLAY

To program a specific segment of the recording to be played back in the FREEZE A program, set the START and END parameters to appropriate values (0 ~ 500). The example below depicts how the START and END parameters affect output.

START/END POINTS	PLAYBACK SIGNAL
	"GOOD LUCK"
	"OOD LUCK"
	"LUCK"
	"OD LU"
	"LUCK GOOD"

Playback can also be triggered by a footswitch connected to the front-panel MEMORY/FOOT TRIGGER jack when the FOOT TRIGGER key is pressed and its LED is ON. A MIDI keyboard connected to the MIDI IN terminal can also be used to trigger playback — simply play a note on the keyboard.

Another way to trigger playback is to use the Input Trigger Parameter. Select the Input Trigger Parameter and press the parameter Increment key to enter the standby mode. Playback will be automatically triggered when the input signal exceeds nominal level.

The FREEZE B program PITCH and FINE parameters function identically to those in the PITCH CHANGE program to change the pitch of the playback signal. Playback start and stop can be triggered by the PARAMETER INCREMENT/DECREMENT keys, foot switch or via a MIDI keyboard connected to the MIDI IN connector. With the FREEZE B program, playing a key on the MIDI keyboard produces the corresponding pitch change in the playback output, and triggers playback.

REVERB and GATE

This program feeds the reverb signal through a gate circuit, making it possible to output only a segment of a longer reverb sound. Parameters provided for the reverb portion of the signal are REV TIME, HIGH, DELAY, HPF and LPF, while parameters for the gate portion are HOLD TIME, RELEASE TIME, and MIDI TRIGGER.

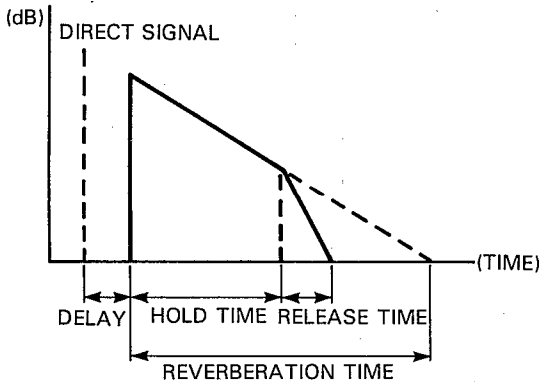

1. **REVERB TIME (R/T).** Range: 0.3 ~ 99.0 sec
2. **HIGH (High Frequency Reverb Time Ratio)** Range: 0.1 ~ 1.0
3. **DELAY.** Range: 0.1 ~ 50.0 msec
4. **HPF (High Pass Filter).** Range: 32 Hz ~ 1.0 kHz, THRU
5. **LPF (Low Pass Filter).** Range: 1.0 kHz ~ 11 kHz
All these parameters have the same function as those of the REV programs. See page 10 for details.
6. **TRIGGER LEVEL.** Range: 0 ~ 100%
Determines the strength (amplitude) of the input signal required to trigger opening of the gate. At 100%, only extremely high-level input signals will trigger the gate, while at 0% even this slightest input signal will trigger the gate.
7. **HOLD TIME.** Range: 1 ~ 30,000 msec
This parameter sets the amount of time the gate is "open," allowing the reverb sound to come through.
8. **RELEASE TIME.** Range: 5 ~ 32,000 msec
This parameter determines the time it takes for the gate to close completely after the HOLD TIME.
9. **MIDI TRIGGER.** Range: ON, OFF
When ON, a KEY ON signal from an external MIDI keyboard can be used to trigger the R & G effect.

GATE

ADR-NOISE GATE

This program uses a gate circuit to pass or shut off the input signal in a number of ways. It can be used to pass just a short segment of a longer input signal, or it can be used to pass only signals that exceed a specific level (noise-gate type operation). It is also possible to achieve reverse gate effects in which the gain increases gradually after the gate is triggered.

In addition to signal-level triggering, it is also possible to trigger the gate via a footswitch connected to the front-panel MEMORY TRIGGER jack when the FOOT TRIGGER key LED is ON.

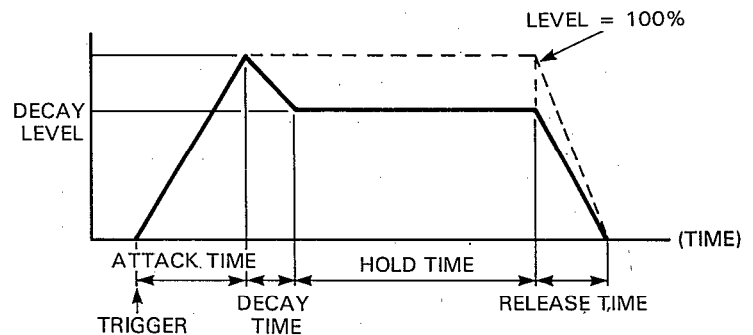

1. **TRIGGER LEVEL.** Range: 1 ~ 100%
Determines the strength (amplitude) of the input signal required to trigger opening of the gate. At 100%, only extremely high level input signals will trigger the gate, while at 0% even the slightest input signal will trigger the gate.
2. **TRIGGER DELAY.** Range: - 100 ~ 100 msec
Produces a delay between the time at which the gate is triggered and that at which it actually opens. If a minus value is programmed, the input signal itself is delayed so that, effectively, the gate opens before the signal appears.
3. **TRIGGER MASK.** Range: 5 ~ 32,000 msec
This parameter makes it impossible to re-trigger the gate function until the programmed time has elapsed.
4. **ATTACK TIME.** Range: 5 msec ~ 32,000 msec
Determines how long it takes for the gate to open fully from the time it begins to open.
5. **DECAY TIME.** Range: 5 msec ~ 32,000 msec
Determines the length of time it takes for the gate to fall to DECAY LEVEL after it is fully open.

6. DECAY LEVEL. Range: 0 ~ 100%

Determines the level at which the gate remains open for the HOLD TIME. The lower the value the lower the HOLD gate level.

7. HOLD TIME. Range: 1 msec ~ 30,000 msec

Determines how long the gate stays open, allowing the input signal to pass.

8. RELEASE TIME. Range: 5 msec ~ 32,000 msec

Determines how long it takes for the gate to close fully from the time it begins to close.

9. MIDI TRIGGER. Range: ON, OFF

When ON, a KEY ON signal from an external MIDI keyboard can be used to trigger the gate.

COMPRESSOR

The COMPRESSOR effect reduces the level of the attack portion of a music signal and keeps overall signal level within narrow limits.

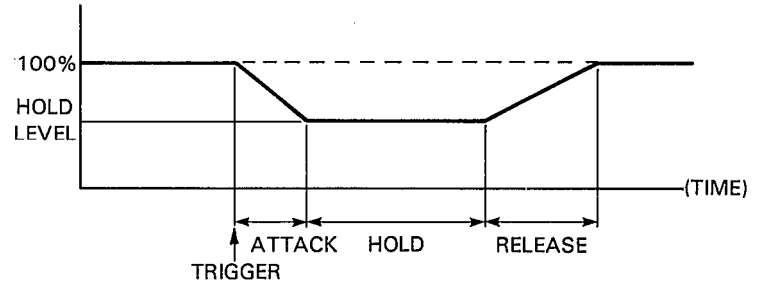

1. TRIGGER LEVEL. Range: 1 ~ 100%

Determines the strength of the attack signal required to trigger the compressor effect.

2. TRIGGER DELAY. Range: - 100 ~ 100 msec

Produces a delay between the time at which the effect is triggered and that at which the compression actually begins. If a negative value is programmed, the input signal is delayed so that effectively, the compression begins before the signal appears.

3. TRIGGER MASK. Range: 5 ~ 32,000 msec

This parameter makes it impossible to re-trigger the compressor function until the programmed time has elapsed.

4. ATTACK TIME. Range: 5 msec ~ 32,000 msec

Determines how long it takes until the HOLD level (below) is reached after the effect is triggered.

5. HOLD TIME. Range: 1 msec ~ 30,000 msec

Determines how long the maximum compression effect is maintained after the ATTACK TIME has elapsed.

6. HOLD LEVEL. Range: 0 ~ 100%

Determines the actual level to which all input signals will be compressed during the HOLD TIME. The smaller the value, the lower the level of the output signal.

7. RELEASE TIME. Range: 5 msec ~ 32,000 msec

Determines how long it takes to return to normal level once the HOLD TIME has elapsed.

8. MIDI TRIGGER. Range: ON, OFF

When ON, a KEY ON signal from an external MIDI keyboard can be used to trigger the compressor effect.

PAN

AUTO PAN

This program automatically pans the sound image between left and right in the stereo sound field. Pan direction, speed, and phase can be programmed.

1. **PAN SPEED. Range: 0.1 ~ 20.0 Hz**
Sets the speed of pan.
2. **DIRECTION. Range: L → R, L ← R, L ↔ R**
Determines the direction of pan.
3. **DEPTH. Range: 0 ~ 100%**
Sets the degree of level variation. The higher the value, the stronger the pan effect.

TRIGGERED PAN

In this program the pan effect is triggered by the input signal or footswitch.

1. **TRIGGER LEVEL. Range: 1 ~ 100%**
Determines the strength of the attack signal required to trigger the pan effect. The higher the value, the higher the input signal level required to trigger the effect.
2. **TRIGGER DELAY. Range: – 100 ~ 100 msec**
Produces a delay between the time at which the effect is triggered and that at which the pan effect actually begins. If a negative value is programmed, the input signal is delayed so that effectively, the pan effect begins before the signal appears.
3. **TRIGGER MASK. Range: 5 ~ 32,000 msec**
This parameter makes it impossible to re-trigger the pan function until the programmed time has elapsed.
4. **ATTACK TIME. Range: 5 msec ~ 32 sec**
Determines how quickly or slowly the pan effect reaches maximum depth after it is triggered.
5. **PANNING TIME. Range: 5 msec ~ 32 sec**
Determines how long the maximum-depth pan effect remains active.
6. **RELEASE TIME. Range: 5 msec ~ 32 sec**
Determines how long it takes for the pan effect to fade out after the PANNING TIME has elapsed.
7. **DIRECTION. Range: L → R, L ← R**
Sets the direction of pan.
8. **L/R BALANCE. Range: 0 ~ 100%**
Determines the volume balance between the left and right channels.
9. **MIDI TRIGGER. Range: ON, OFF**
When ON, a KEY ON signal from an external MIDI keyboard can be used to trigger the pan effect.

NOTE: To use footswitch FC-5, connect the FC-5 to the MEMORY/TRIGGER FOOT Switch Jack and press the Foot Trigger key.

DELAY VIBRATO

This program makes it possible to add delay vibrato effects to virtually any instrument or sound. When the input signal exceeds a programmed trigger level, the vibrato effect is cancelled and then gradually builds up to the programmed depth.

- 1. TRIGGER LEVEL. Range: 1 ~ 100%**
Determines the input signal level at which the vibrato effect is cancelled and begins to build up again.
- 2. VIBRATO DELAY. Range: 1 ~ 30,000 msec**
Determines how long the vibrato effect is cancelled once triggered.
- 3. VIBRATO RISE TIME. Range: 5 msec ~ 32,000 msec**
Determines how long it takes for the vibrato effect to reach maximum depth after the VIBRATO DELAY time has elapsed.
- 4. VIBRATO FREQUENCY. Range: 0.1 ~ 20.0 Hz**
This parameter sets the frequency (speed) of the vibrato effect.
- 5. VIBRATO DEPTH. Range: 0 ~ 100%**
Sets the depth (strength) of the vibrato effect.
- 6. MIDI TRIGGER. Range: ON, OFF**
When ON, a KEY ON signal from an external MIDI keyboard can be used to trigger the vibrato effect.

PARAMETRIC EQ

This program permits variation of the input signal frequency response over an extremely broad range.

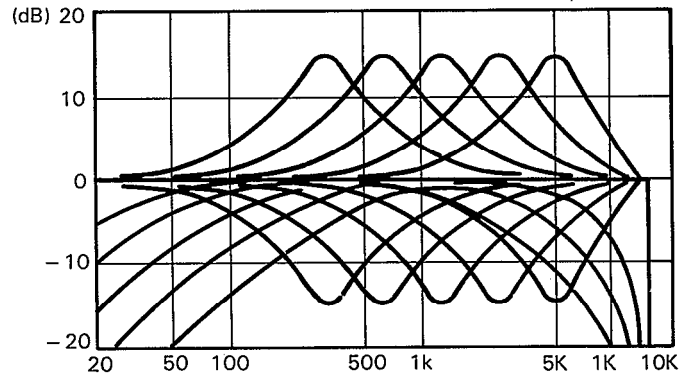

- 1. HPF. Range: THRU, 32 Hz ~ 1.0 kHz.**
This sets the cutoff frequency of the high-pass filter. Frequencies below the set frequency are rolled off at a rate of 6 dB/octave. When set to THRU, the HPF is OFF.
- 2. MID FRQ. Range: 315 Hz ~ 4.0 kHz**
Determines the center frequency of the midrange equalization band. The midrange frequency can be set in 1/6 octave increments.
- 3. MID GAIN. Range: - 15 ~ + 15 dB**
Determines the amount of boost or cut applied to the midrange equalization band.
- 4. MID Q. Range: 0.5 ~ 5.0**
Sets the "Q" (Quality factor = bandwidth) of the midrange EQ band. The higher the value, the narrower the bandwidth.
- 5. HI FRQ. Range: 800 Hz ~ 8.0 kHz**
Determines the center frequency of the high-frequency equalization band.
- 6. HI GAIN. Range: - 15 ~ + 15 dB**
Determines the amount of boost or cut applied to the high-frequency equalization band.
- 7. HI Q. Range: 0.5 ~ 5.0**
Sets the "Q" (Quality factor = bandwidth) of the high EQ band. The higher the value, the narrower the bandwidth.
- 8. LPF. Range: 1 kHz ~ 11 kHz, THRU**
Determines the cutoff frequency of the low-pass filter.
- 9. DELAY. Range: 0.1 ~ 400.0 msec**
Sets the delay time of equalized signal following the direct signal.

SAMPLE APPLICATIONS

MIDI KEYBOARD PERFORMANCE SYSTEM

In this system the SPX90 is connected immediately following a MIDI keyboard, and its output feeds either an instrument amplifier or sound reinforcement mixing console. The MIDI OUT terminal of the keyboard is connected to the MIDI IN terminal of the SPX90, permitting automatic selection of different effects programs for specific voices selected at the keyboard. The SPX90 is under direct control of the keyboard player (rather than the mixing engineer) so he can produce exactly the effects he wants for each voice or musical selection. In a multi-keyboard system the SPX90 could be patched into the effects loop of the keyboard mixer. The MIDI keyboards could be chained together via the MIDI THRU terminals (MIDI OUT → MIDI IN → MIDI THRU → MIDI IN → MIDI THRU → etc.) with the SPX90 MIDI IN terminal fed from the MIDI THRU terminal of the last keyboard in the chain. This way, all keyboards in the system could be used for MIDI effect selection. (SYSTEM DIAGRAM 1)

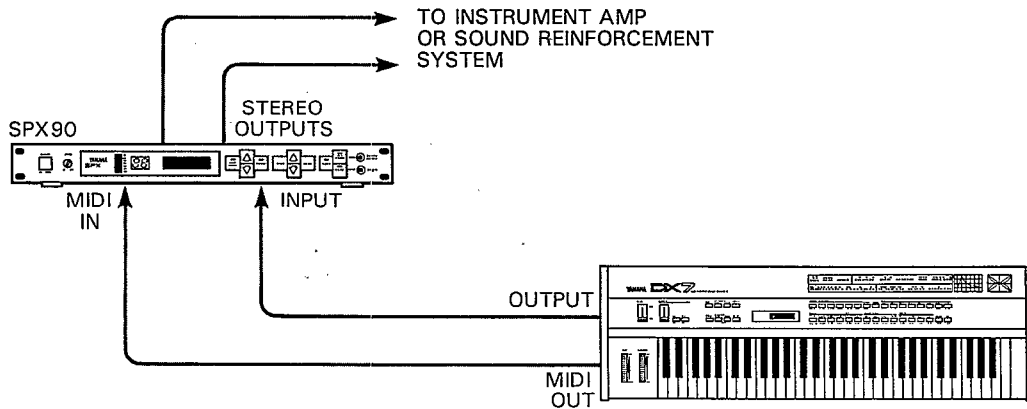

BASIC SOUND REINFORCEMENT SYSTEM

The SPX90 is an excellent addition to the small to medium size sound reinforcement system. Its input can be fed from either a mono effects send or auxilliary send bus on the mixing console, and its stereo outputs can be fed back to the corresponding effects or auxilliary return inputs on the console. Assuming the console used has independent effects or auxilliary send level controls on each input channel, it is possible to add the required amount of SPX90 effect to each input. It is also possible to use two SPX90 units for full stereo reverb and effects in a larger system.

(SYSTEM DIAGRAM 2)

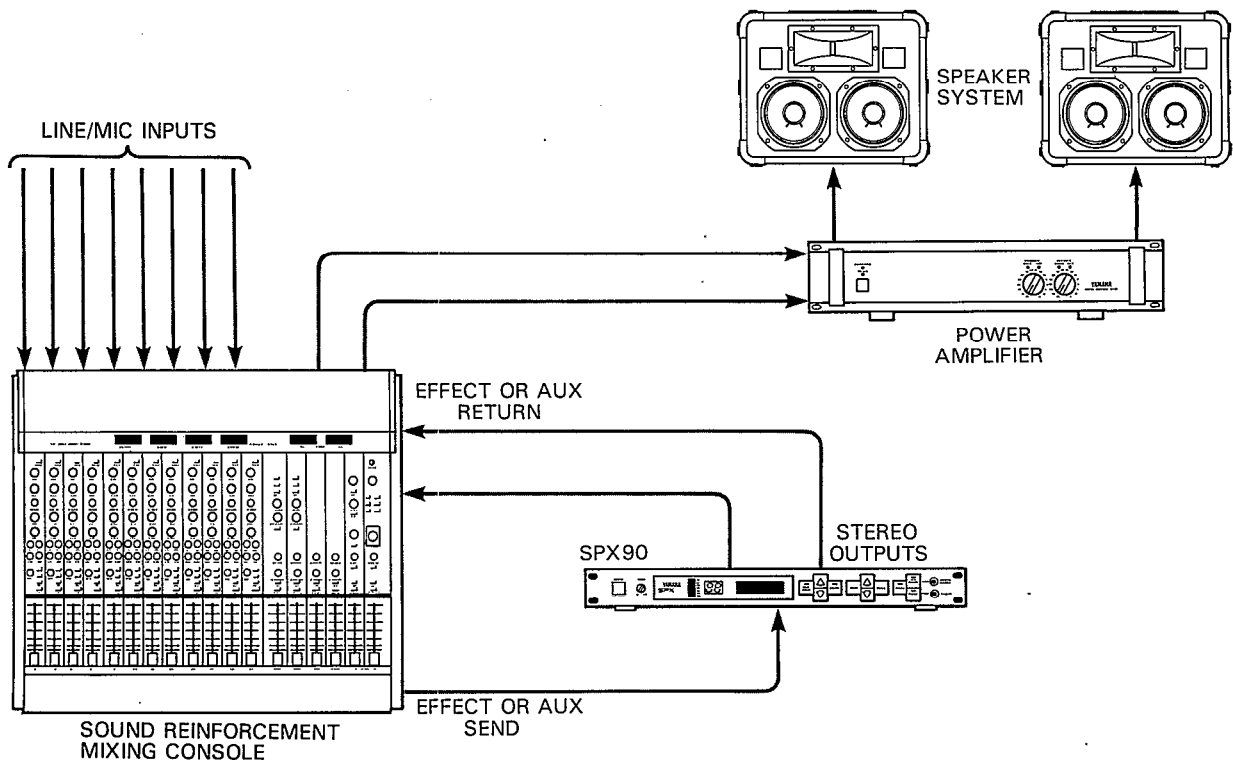

RECORDING SYSTEM

In a recording system it is most desirable to have the SPX90 input and outputs available at a patch bay where they may be accessed and patched into virtually any part of the system. In some cases it might be best to have the SPX90 connected directly in line between the source and the mixing console inputs, while in other situations—final mixdown, for example—the SPX90 should be patched into the mixing console's effects loop so it may be applied to the entire mix. Naturally, the SPX90 is also an ideal choice for the truly modern digital sequencer recording system, too.

(SYSTEM DIAGRAM 3)

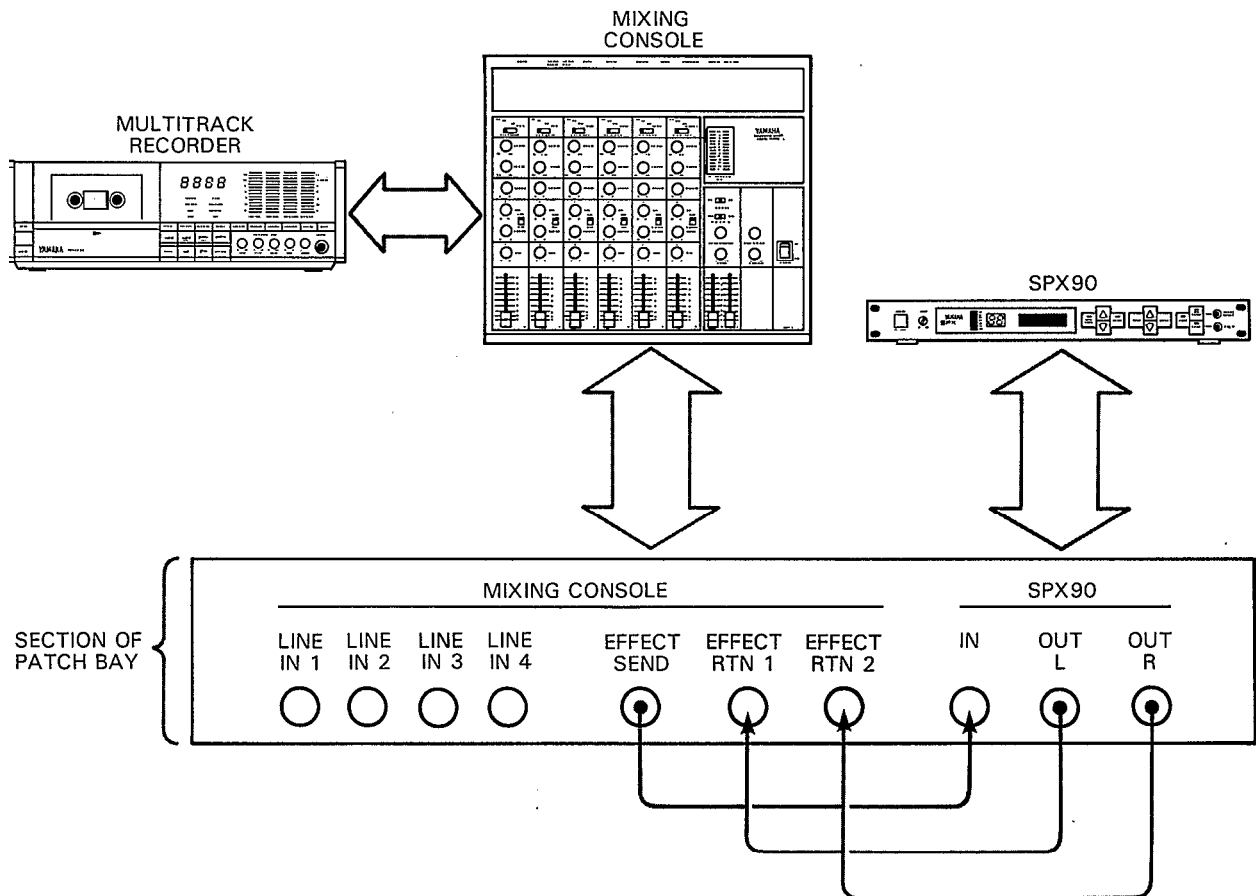

SPECIFICATIONS

INPUT

Number of Channels	Unbalanced x 1 (Phone Jack)
Nominal Level	- 20 dBm/+4 dBm, Selectable
Impedance	10 k-ohms
Level Control	Volume, Max. Gain + 12 dB
Level Monitor	7 points LED

A/D CONVERSION

Sampling Freq.	31.25 kHz
Quantization	Linear 16 Bit
Band Width	20 Hz to 12 kHz
Number of Channels	1

D/A CONVERSION

Number of Channels	2
Sampling Freq.	31.25 kHz
Quantization	Linear 16 Bit
Band Width	20 Hz to 12 kHz

OUTPUT

Number of Channels	Unbalanced x 2 (Phone Jack)
Nominal Level	- 20 dBm/+4 dBm, Selectable
Impedance	600 ohms
Mixing	Direct Signal, Effect Signal
Bypass	ON/OFF

MEMORY

Presets (ROM)	1 ~ 30
User Memory (RAM)	31 ~ 90 (Non Volatile)
	All parameters except Input Level, can be memorized
	Key On triggers the program 18, 19, 20, 28 and 29

MIDI CONTROL

MIDI Channel (1 to 16, OMNI), (4 banks), Program Number (1 to 128)
 Note on/off is recognized only for pitch change A, D and freeze B

FRONT PANEL

Display	16 character 2 lines LCD x 1, 2 digits numeric LED for Memory No., 7 points level meter LED
Knob	Input Level Volume
Keys	Parameter/Balance/Data Increment/Data Decrement, Memory Store/ Recall/Data Increment/Data Decrement, Utility/Foot Trigger/Bypass

ELECTRICAL CHARACTERISTICS

Dynamic Range	Reverb: more than 75 dB Delay : more than 81 dB
Distortion	Bypassed Signal: less than 0.01% Effect Signal : less than 0.03%
Band Width	Bypassed Signal: 20 Hz to 20 kHz Effect Signal : 20 Hz to 12 kHz

POWER SUPPLY

U. S. & Canadian Models	110V - 120V, 60Hz
General Model	220V - 240V, 50/60Hz

POWER CONSUMPTION

U. S. & Canadian Models	20W
General Model	20W

DIMENSIONS (W x H x D)

480mm x 45.2mm x 285mm
 (18-7/8" x 1-3/4" x 11-1/4")

WEIGHT

3.2 kg (7 lbs)

OPTIONAL REMOTE CONTROL (model RC7)

PRESET PROGRAM 1 ~ 30, USER MEMORY 31 ~ 37

* *NOTE: Since natural sounding reverberation is mixed with the direct sound, and hence does not constitute 100% of the sound, the effective dynamic range will nearly always exceed 90 dB.*

** *0 dBu is 0.775 volts RMS. This value represents voltage across a high impedance input. dBu is the equivalent of dBu if specified across a 600 ohm load.*

ROM CONTENTS AND CONTROLABLE PARAMETERS

MEM No.	PROGRAM NAME	TYPE	PARAMETERS							BALANCE			
			1	2	3	4	5	6	7	8	9	BALANCE	OUT LVL
1	REV 1 HALL	REV	REV TIME 2.6s (0.3-99.0s)	HIGH 0.6 (0.1-1.0)	DELAY 30.0ms (0.1-50.0ms)	HFF THRU (THRU, 32Hz-1.0kHz)	LPF 8.0kHz (1.0kHz-11kHz, THRU)					100% (0-100%)	100% (0-100%)
2	REV 2 ROOM		REV TIME 1.5s (0.3-99.0s)	HIGH 0.7 (0.1-1.0)	DELAY 20.0ms (0.1-50.0ms)	HFF THRU (THRU, 32Hz-1.0kHz)	LPF 8.0kHz (1.0kHz-11kHz, THRU)					100% (0-100%)	100% (0-100%)
3	REV 3 VOCAL		REV TIME 4s (0.3-99.0s)	HIGH 0.5 (0.1-1.0)	DELAY 45.0ms (0.1-50.0ms)	HFF 80Hz (THRU, 32Hz-1.0kHz)	LPF 8.0kHz (1.0kHz-11kHz, THRU)					100% (0-100%)	100% (0-100%)
4	REV 4 PLATE		REV TIME 8s (0.3-99.0s)	HIGH 0.7 (0.1-1.0)	DELAY 10.0ms (0.1-50.0ms)	HFF 40Hz (THRU, 32Hz-1.0kHz)	LPF 10.0kHz (1.0kHz-11kHz, THRU)					100% (0-100%)	100% (0-100%)
5	EARLY REF 1	E/R 1	TYPE HALL (REVERSE/PLATE)	ROOM SIZE 2.0 (0.1-20.0)	LIVENESS 5 (0-10)	DELAY 10.0ms (0.1-400.0ms)	LPF THRU (1.0kHz-11kHz, THRU)					100% (0-100%)	100% (0-100%)
6	EARLY REF 2	E/R 2	TYPE HALL (REVERSE/PLATE)	ROOM SIZE 2.0 (0.1-20.0)	LIVENESS 5 (0-10)	DELAY 10.0ms (0.1-400.0ms)	LPF THRU (1.0kHz-11kHz, THRU)					100% (0-100%)	100% (0-100%)
7	DELAY L R	DELAY	Lch DLY 00.0ms (0.0-0.0ms)	Lch F.B. 0 (-99-+99%)	Rch DLY 200.0ms (0.1-500.0ms)	Rch F.B. 0 (-99-+99%)	HIGH 1.0 (0.1-1.0)					100% (0-100%)	100% (0-100%)
8	STEREO ECHO	ECHO	Lch DLY 0ms (0.0-0.0ms)	Lch F.B. 60 (-99-+99%)	Rch DLY 178.0ms (0.1-250.0ms)	Rch F.B. 58 (-99-+99%)	HIGH 0.9 (0.1-1.0)					100% (0-100%)	100% (0-100%)
9	STEREO FLANGE A	MOD	MOD. FRQ 50Hz (0.0-20.0Hz)	MOD. DEPTH 50% (0-100%)	MOD. DLY 1.2ms (0.1-100.0ms)	F.B. GAIN 35% (0-99%)						50% (0-100%)	100% (0-100%)
10	STEREO FLANGE B		MOD. FRQ 50Hz (0.0-20.0Hz)	MOD. DEPTH 90% (0-100%)	MOD. DLY 1.0ms (0.1-100.0ms)	F.B. GAIN 40% (0-99%)						75% (0-100%)	100% (0-100%)
11	CHORUS A		MOD. FRQ 0.2Hz (0.1-20.0Hz)	MOD. DEPTH 50% (0-100%)	MOD. DLY 40% (0-100%)							100% (0-100%)	100% (0-100%)
12	CHORUS B		MOD. FRQ 0.8Hz (0.1-20.0Hz)	MOD. DEPTH 50% (0-100%)	MOD. DLY 10% (0-100%)							100% (0-100%)	100% (0-100%)
13	STEREO PHASING		MOD. FRQ 1.1Hz (0.1-20.0Hz)	MOD. DEPTH 100% (0-100%)	MOD. DLY 3.0ms (0.1-8.0ms)							100% (0-100%)	100% (0-100%)
14	TREMOLO		MOD. FRQ 6.0Hz (0.1-20.0Hz)	MOD. DEPTH 50% (0-100%)								100% (0-100%)	100% (0-100%)
15	SYMPHONIC		MOD. FRQ 0.7Hz (0.1-20.0Hz)	MOD. DEPTH 50% (0-100%)								100% (0-100%)	100% (0-100%)
16	GATE REVERB	E/R2	TYPE RANDOM (HALL/RANDOM REVERSE/PLATE)	ROOM SIZE 2.0 (0.1-20.0)	LIVENESS 5 (0-10)	DELAY 20.0ms (0.1-400.0ms)	LPF 6.3kHz (1.0kHz-11kHz, THRU)					100% (0-100%)	100% (0-100%)
17	REVERSE GATE		TYPE REVERSE (HALL/RANDOM REVERSE/PLATE)	ROOM SIZE 3.3 (0.1-20.0)	LIVENESS 5 (0-10)	DELAY 25.0ms (0.1-400.0ms)	LPF THRU (1.0kHz-11kHz, THRU)					100% (0-100%)	100% (0-100%)
18	ADR NOISE GATE	GATE	TRG. LEVEL 65 (1-100)	TRG. DLY -7ms (-100-100ms)	TRG. MSK 5ms (5-3200ms)	ATTACK 5ms (5-3200ms)	DECAY 5ms (5-3200ms)	DECAY LVL 100% (0-100%)	HOLD 90ms (1-3000ms)	RELEASE 5ms (5-3200ms)	MIDI TRG. OFF (OFF/ON)	100% (0-100%)	100% (0-100%)
19	COMPRESSOR		TRG. LEVEL 69 (1-100)	TRG. DLY -25ms (-100-100ms)	TRG. MSK 42ms (5-3200ms)	ATTACK 22ms (5-3200ms)	HOLD 28ms (1-3000ms)	HOLD LEVEL 1% (0-100%)	RELEASE 52ms (5-3200ms)	MIDI TRG. OFF (OFF/ON)		100% (0-100%)	100% (0-100%)
20	REVERB & GATE	R&G	REV TIME 2.0s (0.3-99.0s)	HIGH 0.6 (0.1-1.0)	DELAY 10.0ms (0.1-50.0ms)	HFF THRU (THRU, 31Hz-1.0kHz)	LPF THRU (1.0kHz-11kHz, THRU)	TRG. LEVEL 65 (1-100)	HOLD 150ms (1-3000ms)	RELEASE 5ms (5-3200ms)	MIDI TRG. OFF (OFF/ON)	100% (0-100%)	100% (0-100%)
21	PITCH CHANGE A	PITCH	PITCH 0 (-12-12)	FINE 0 (-100-100)	DELAY 0.1ms (0.1-400.0ms)	F.B. GAIN 0% (0-99%)	BASE KEY C3 (OFF, C1-C6)					100% (0-100%)	100% (0-100%)
22	PITCH CHANGE B		1 PITCH 0 (-12-12)	1 FINE 0 (-100-100)	1 DLY 0.1ms (0.1-400.0ms)	1 PITCH 0 (-12-12)	1 FINE 0 (-100-100)	1 DLY 20.0ms (0.1-400.0ms)				100% (0-100%)	100% (0-100%)
23	PITCH CHANGE C		L PITCH 0 (-12-12)	L FINE 0 (-100-100)	L DLY 0.1ms (0.1-200.0ms)	R PITCH 0 (-12-12)	R FINE 0 (-100-100)	R DLY 0.1ms (0.1-200.0ms)				100% (0-100%)	100% (0-100%)
24	PITCH CHANGE D		PITCH 0 (-12-12)	FINE 0 (-100-100)	DELAY 0.1ms (0.1-400.0ms)	F.B. GAIN 0% (0-99%)	BASE KEY C3 (OFF, C1-C6)					100% (0-100%)	100% (0-100%)
25	FREEZE A	FREEZE	REC. MODE AUTO (MANUAL/AUTO)	TRG. DLY -5ms (-500-500ms)	RECORD	OVER DUB	PLAY	START 0 (0-500)	END 500 (0-500)	INPUT TRG. OFF (OFF/ON)		100% (0-100%)	100% (0-100%)
26	FREEZE B		REC. MODE MANUAL (MANUAL/AUTO)	TRG. DLY -50ms (-500-500ms)	RECORD	OVER DUB	PLAY	PITCH 0 (-12-12)	FINE 0 (-100-100)	BASE KEY C3 (OFF, C1-C6)		100% (0-100%)	100% (0-100%)
27	AUTO PAN	PAN	PAN SPEED 0.7Hz (0.1-20.0Hz)	DIRECTION L/R (L-R)	DEPTH 75% (0-100%)							100% (0-100%)	100% (0-100%)
28	TRIGGERED PAN		TRG. LEVEL 65 (1-100)	TRG. DLY 10ms (-100-100ms)	TRG. MSK 100ms (5-3200ms)	ATTACK 22ms (5-3200ms)	PANNING 525ms (5-3200ms)	RELEASE 840ms (5-3200ms)	DIRECTION L-R (L-R, L-R)	L/R BALANCE 30% (0-100%)	MIDI TRG. OFF (OFF/ON)	100% (0-100%)	100% (0-100%)
29	DELAY VIBRATO	VIB	TRG. LEVEL 100 (1-100)	VIB DLY 400ms (0-3000ms)	VIB RISE 1400ms (5-3200ms)	VIB FRQ 7.0Hz (0.1-20.0Hz)	VIB DEPTH 40% (0-100%)	MIDI TRG. ON (OFF/ON)				100% (0-100%)	100% (0-100%)
30	PARAMETRIC EQ	PEQ	HFF THRU (THRU, 32Hz-1.0kHz)	MOD. FRQ 500Hz (1315Hz-4.0kHz)	MOD. GAIN 0dB (-15-15dB)	MOD. Q 1.0 (0.5-5.0)	HI FRQ 2.0kHz (800Hz-8.0kHz)	HI GAIN 0dB (-15-15dB)	HI Q 1.0 (0.5-5.0)	LPF THRU (1.0kHz-10.0kHz, THRU)	DELAY 0.1ms (0.1-400.0ms)	100% (0-100%)	100% (0-100%)

EARLY REFLECTION MODE CHART

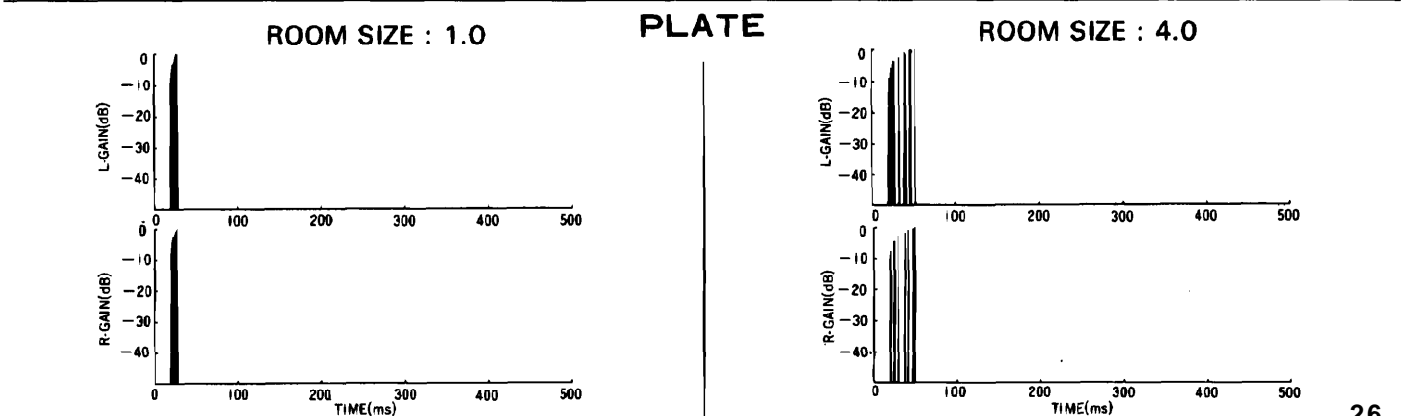
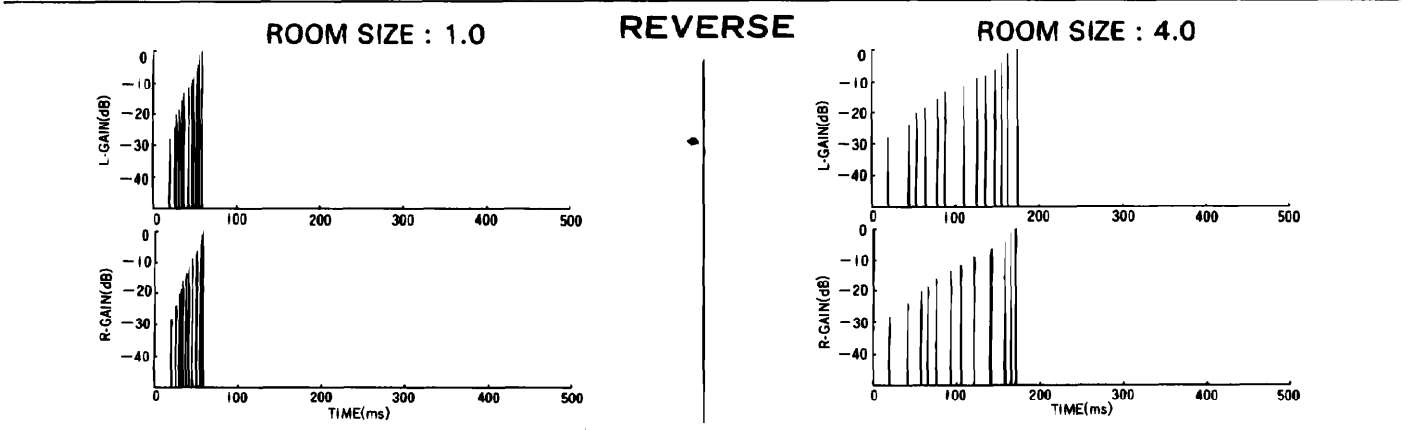
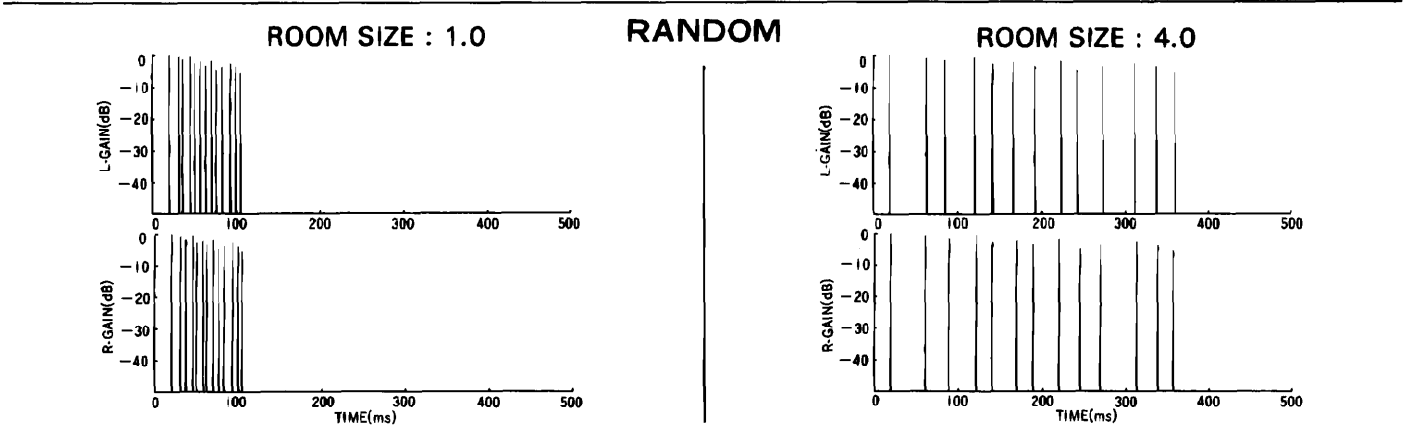
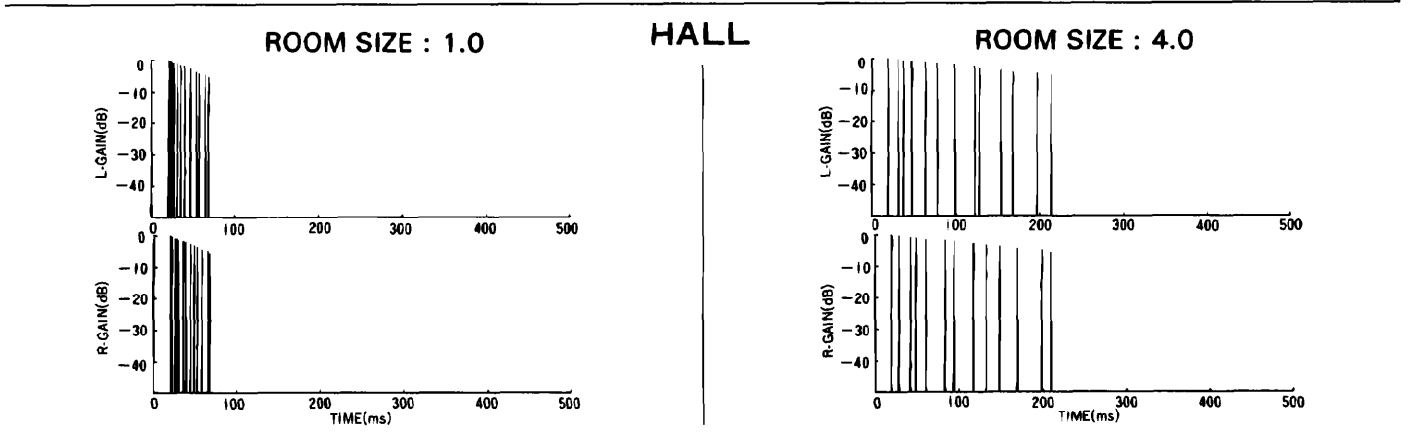

ROOM SIZE CHART

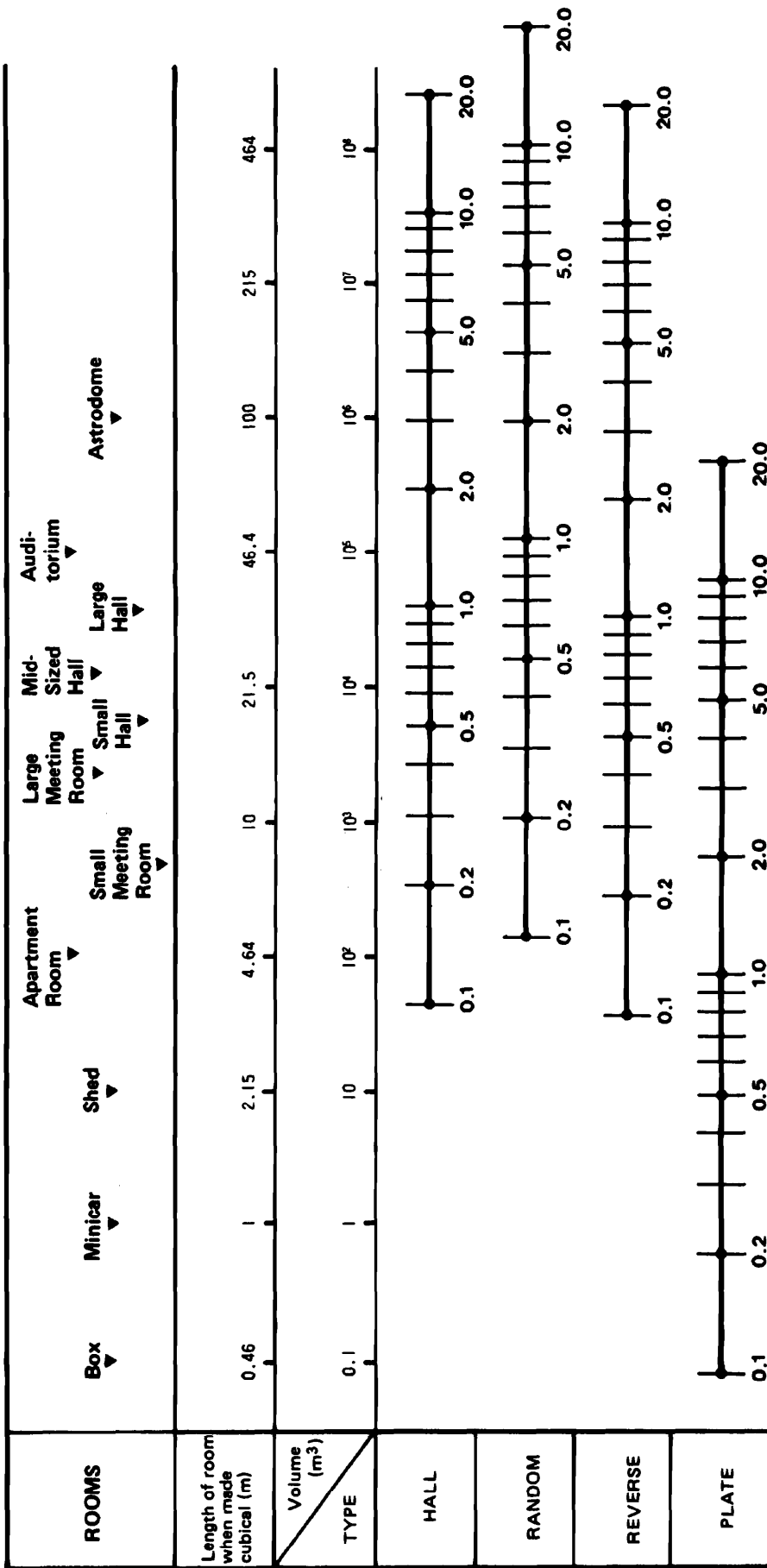

BLOCK DIAGRAM

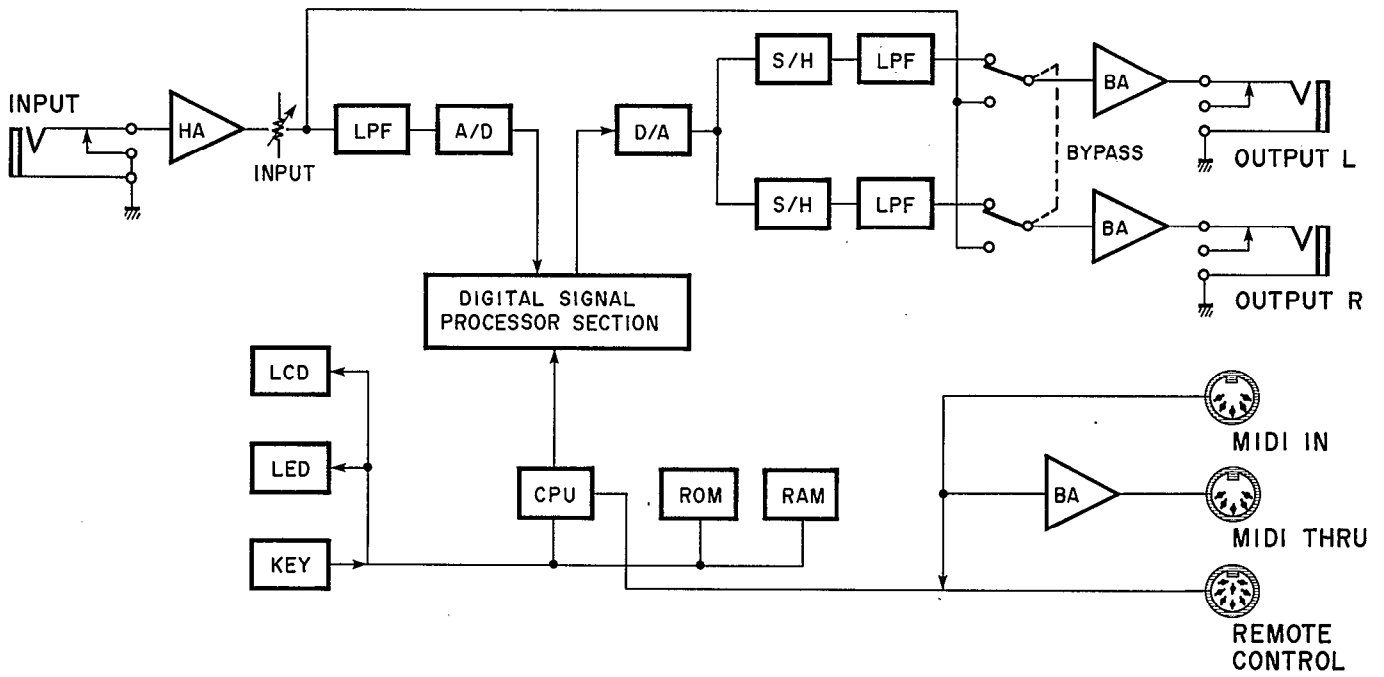

DIMENSIONS

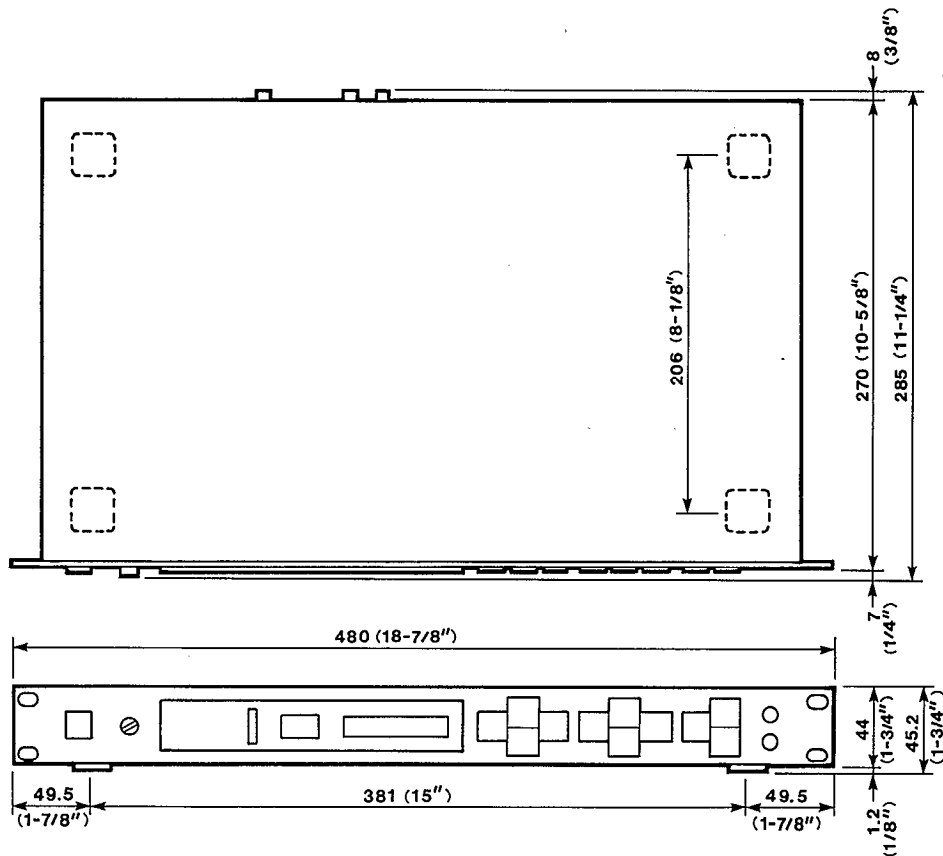

Unit : mm (Inch)

USER PROGRAMMING TABLE

Program No. _____

Program Title _____

Type _____

Parameter	New Value	Parameter	New Value

Remarks _____

Program No. _____

Program Title _____

Type _____

Parameter	New Value	Parameter	New Value

Remarks _____

Function . . .	Recognized	Remarks
Basic Default	1 - 16	memorized
Channel Changed	1 - 16	
Mode Default	OMNI OFF/OMNI ON	memorized
Mode Messages	x	
Mode Altered	x	
Note Number : True voice	o 0 - 127 x	* 1
Velocity Note ON	x	
Velocity Note OFF	x	
After Key's	x	
Touch Ch's	x	
Pitch Bender	x	
	x	
Control		
Change		
Prog Change : True #	o 0-127 x	* 2
System Exclusive	o	
System : Song Pos	x	
System : Song Sel	x	
Common : Tune	x	
System : Clock	x	
Real Time : Commands	x	
Aux : Local ON/OFF	x	
Aux : All Notes OFF	x	
Mes- : Active Sense	x	
sage : Reset	x	
Notes	* 1 Note ON/OFF is recognized only for pitch change and freeze B.	
	* 2 For program 1 - 128, memory #1 - #90 is selected.	



SERVICE

The SPX90 is supported by Yamaha's worldwide network of factory trained and qualified dealer service personnel. In the event of a problem, contact your nearest Yamaha dealer.