

# PRELUDE™

## Fresnel, PC and profile spotlights

### 650W

#### Features

The proven success of the Prelude range is a testimony to the quality of its optics and its compact yet durable design

- ❑ Range comprises fresnel and PC spot and two variable beam angle profile spots
- ❑ All models feature drop down lamp tray for easy lamp access and reflector cleaning
- ❑ Mains supply isolated when lamptray opened
- ❑ Durable construction of pressure die cast and extruded aluminium



Prelude F

Prelude PC

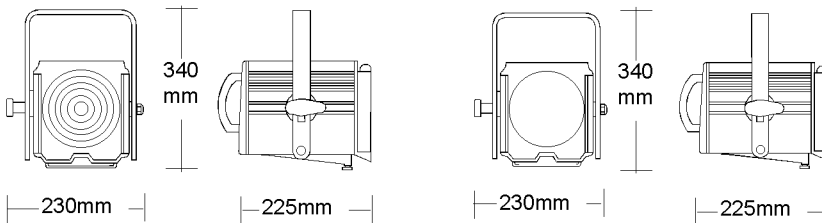

Prelude 28/40  
 Prelude 16/30

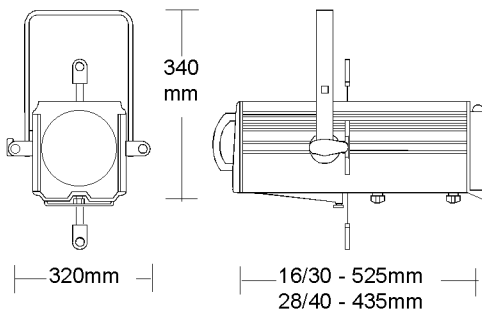

#### Weights and Dimensions

	F	PC	16/30	28/40
Weight	3.5kg	3.6kg	6.5kg	6.3kg
Packed Weight	4.5kg	4.8kg	8.3kg	7.7kg
Packed Volume	0.032m <sup>3</sup>	0.036m <sup>3</sup>	0.07m <sup>3</sup>	0.06m <sup>3</sup>

## Photometric data

Typical performance based on laboratory readings using T26 650W lamp

### Prelude F: Spot

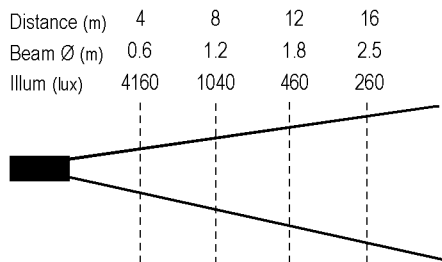

### Prelude PC: Spot

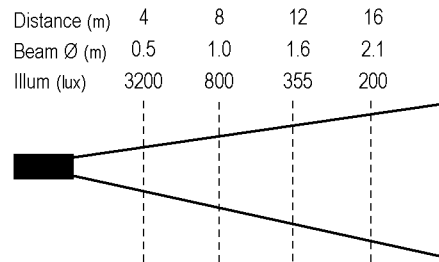

### Prelude F: Flood

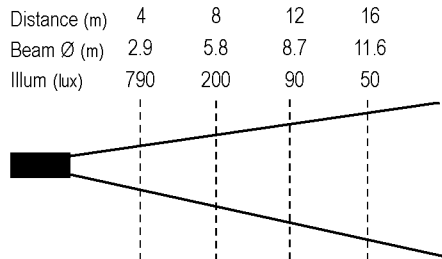

### Prelude PC: Flood

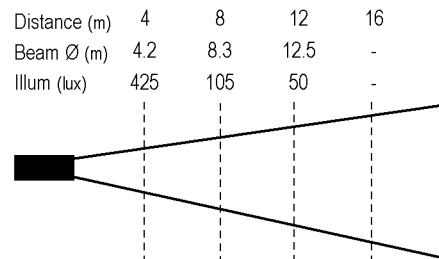

To calculate lux levels at any throw distance divide the following factors by the distance squared:

	Prelude F	Prelude PC	Prelude 16/30	Prelude 28/40
Spot/Narrow	66570	51145	63575	34715
Flood/Wide	12665	6790	36380	21860

e.g. Prelude PC at full flood over 5m throw  $6790/25 = 272\text{Lux}$



**Prelude 16/30: Narrow (16°)**

Distance (m)	4	8	12	16
Beam Ø (m)	1.1	2.2	3.4	4.5
Illum (lux)	3975	1000	440	250

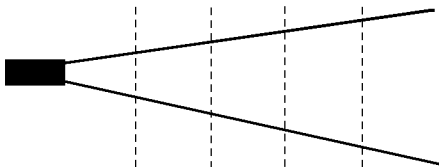

**Prelude 28/40: Narrow (28°)**

Distance (m)	4	8	12	16
Beam Ø (m)	2.0	4.0	6.0	8.0
Illum (lux)	2170	540	240	135

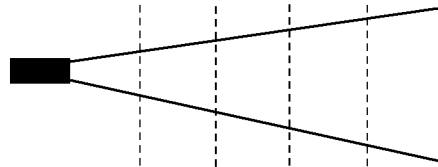

**Prelude 16/30: Wide (30°)**

Distance (m)	4	8	12	16
Beam Ø (m)	2.3	4.6	6.9	9.2
Illum (lux)	2275	570	250	140

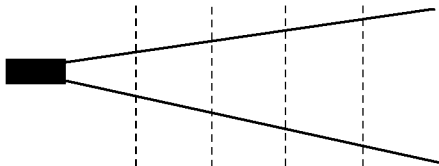

**Prelude 28/40 Wide (40°)**

Distance (m)	4	8	12	16
Beam Ø (m)	2.9	5.8	8.7	11.6
Illum (lux)	1370	340	150	85

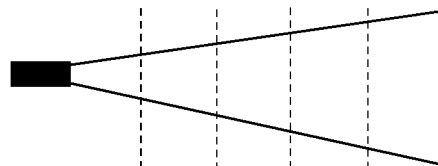

To calculate beam diameters at any throw distance multiply the throw in metres by the following factors:

	Prelude F	Prelude PC	Prelude 16/30	Prelude 28/40
Spot/Narrow	0.13	0.15	0.28	0.5
Flood/Wide	0.64	0.98	0.57	0.73

e.g. Prelude PC at full flood over 5m throw  $0.98 \times 5 = 4.9\text{m}$



## Ordering information

Prelude spotlights are supplied complete with 1.5m of detachable cable with IEC 320 appliance connector and fitted plug, metal colour frame and T26 650W lamp. 240V models come with 15A plug and 240V lamp. 230V models come with Schuko connector and 230V lamp.

### Cat No Description

11104	Prelude F, 240V T26 650W lamp, 15A plug
11103	Prelude F, 230V T26 650W lamp, Schuko plug
11114	Prelude PC, 240V T26 650W lamp, 15A plug
11113	Prelude PC, 230V T26 650W lamp, Schuko plug
11124	Prelude 16/30, 240V T26 650W lamp, 15A plug
11123	Prelude 16/30, 230V T26 650W lamp, Schuko plug
11134	Prelude 28/40, 240V T26 650W lamp, 15A plug
11103	Prelude 28/40, 230V T26 650W lamp, Schuko plug

### Optional accessories

18040	Barndoor, 4 leaf rotatable
18045	Gobo Holder for 'B' size gobos
18046	Iris, 18 leaf
18043	Colour frame, card
18044	Additional colour frame, metal
82010	Hook Clamp
82000	Safety cable, light duty (up to 16kg)
41264	Additional T26 Lamp 650W, 3050K, 400Hr - 240V
41263	Additional T26 Lamp 650W, 3050K, 400Hr - 230V

## Operational Data

### Lamp Access

Through drop down lamp tray secured by quarter turn fastener. Lamp tray can only be opened after removal of power connector ensuring full electrical isolation.

### Focus Adjustment

Slide adjustment by means of locking knob on underside of lampray (F & PC) or lenstube (profiles).

### Lamp Adjustment

Beam distribution on profiles adjusted by locking knob on underside of lampray

### Accessories

Colour runners take DIN standard 150 x 150mm colour frames

## Mechanical/Electrical Data

### Construction

Pressure die cast lamphouse assembly. Profile lenstubes of extruded aluminium sides and die cast front with steel top and bottom panels.

### Lenses

Heat resistant borosilicate lenses. F & PC lenses mounted in die cast front panel. Profile lenses housed in pressed steel carriers

### Lampholder

GY9.5 to take lamps of 46mm LCL and maximum of 650W

### Supply Voltage

230V +/- 10% 50/60 Hz

### Standards compliance

Designed to conform to EN 60 598 2-17

The Company reserves the right to make any variation in design or construction to the equipment described. © Strand Lighting Ltd 1998. Strand™ and Strand Lighting™ are trade marks of Strand Lighting Limited and Strand Lighting Inc.